

Model # : Y-H936A
Assembly Instruction

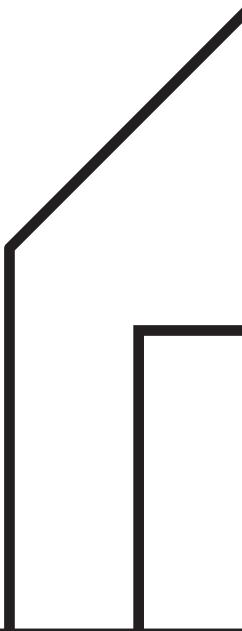

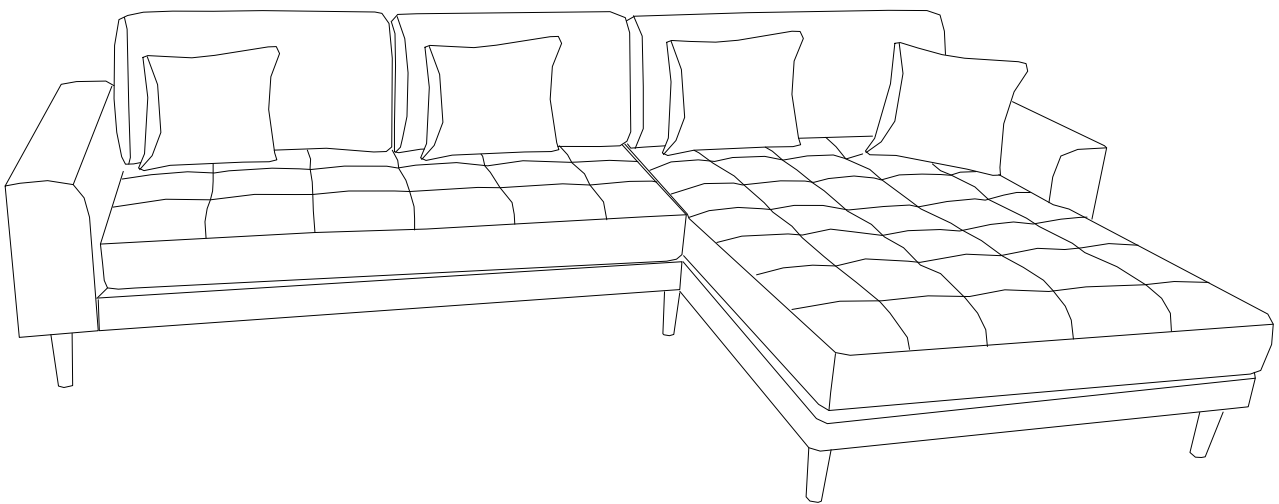

A × 4

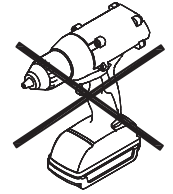
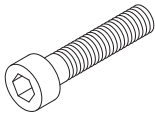

M8×20 mm

B × 12

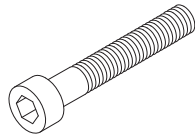

M8×50 mm

C × 4

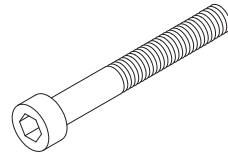

M8×70 mm

D × 2

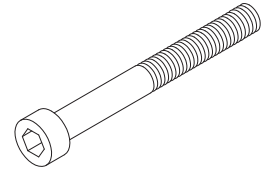

M8×120 mm

E × 4

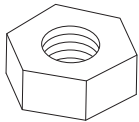

M8/14 mm

F × 26

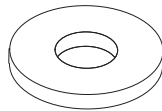

Ø8/Ø22 mm

G × 1

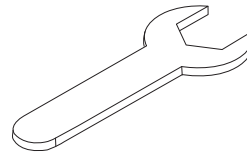

14 mm

H × 1

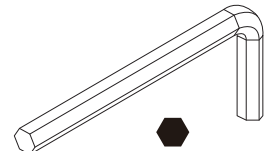

6 mm

J × 8

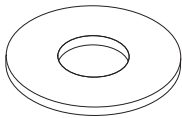

Ø12/Ø24 mm

K × 8

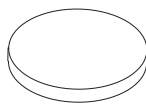

Ø25×3 mm

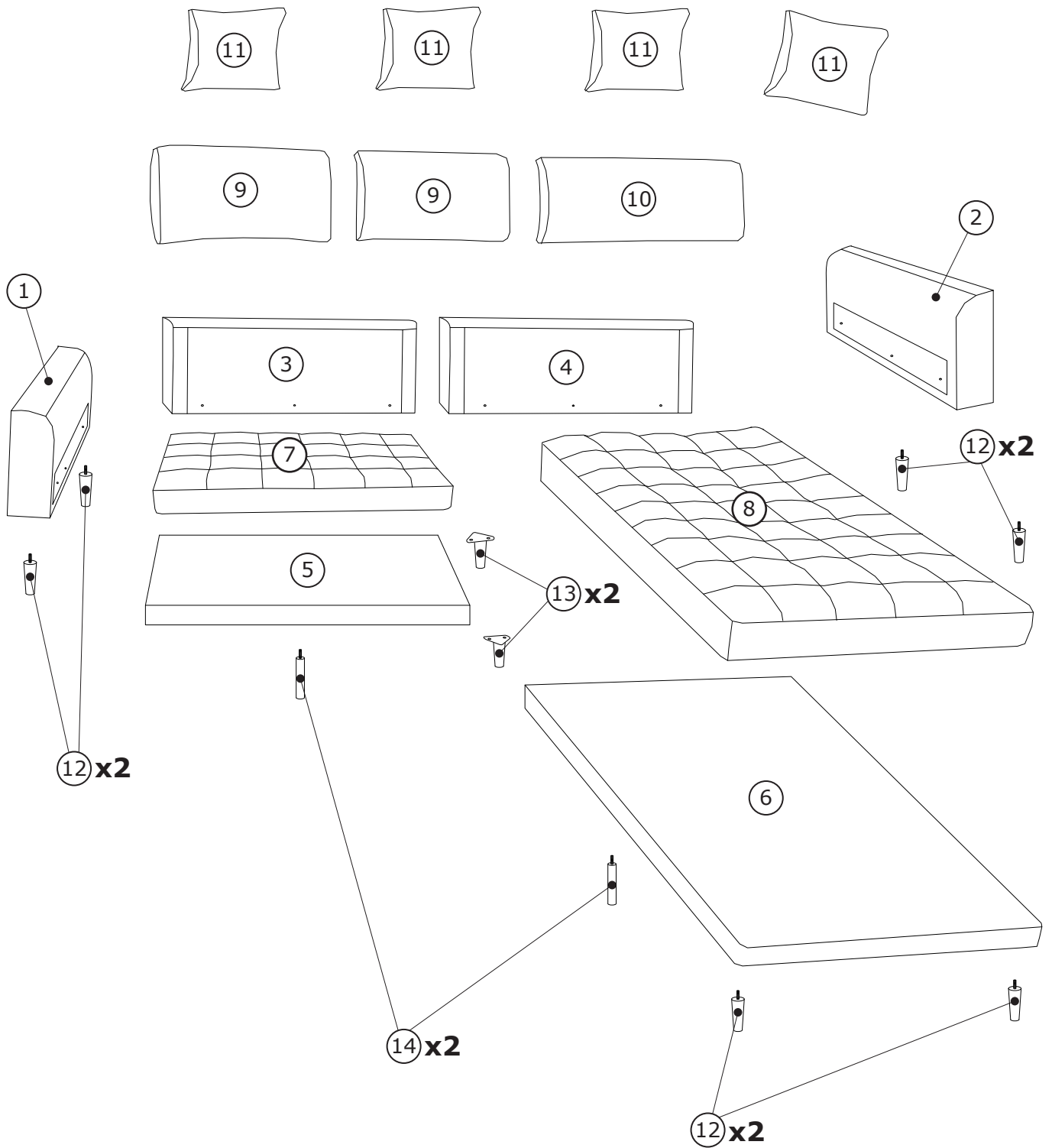

Box 1/4:

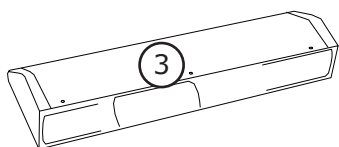

1465×490×200mm

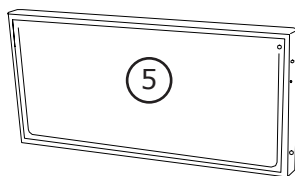

1470×690×95mm

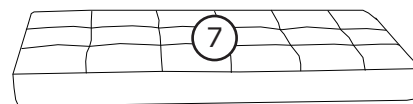

1460×700×180mm

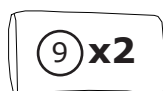

740×430×210mm

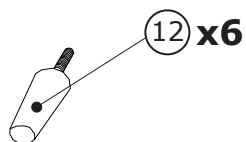

Ø50×Ø32×150mm

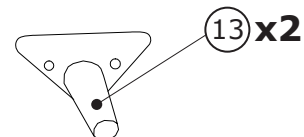

125×125×150mm

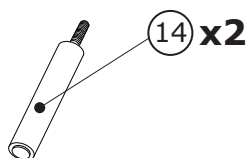

Ø30×145mm

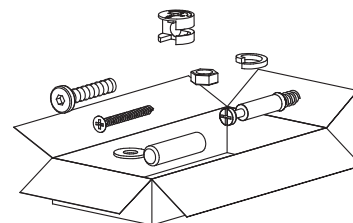

Box 2/4:

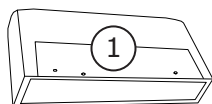

890×490×150mm



890×490×150mm

Box 3/4:

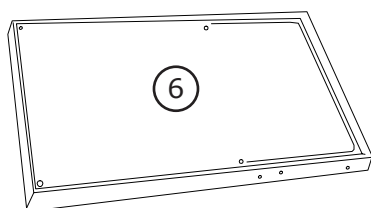

1540×1110×95mm

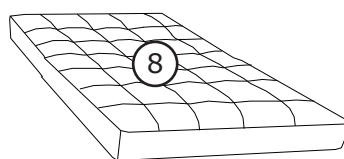

1560×1130×180mm

Box 4/4:

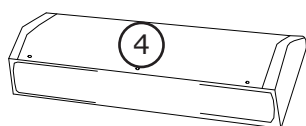

1105×490×200mm

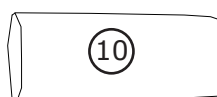

1120×430×210mm

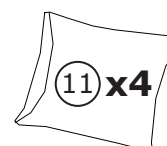

430×430×150mm

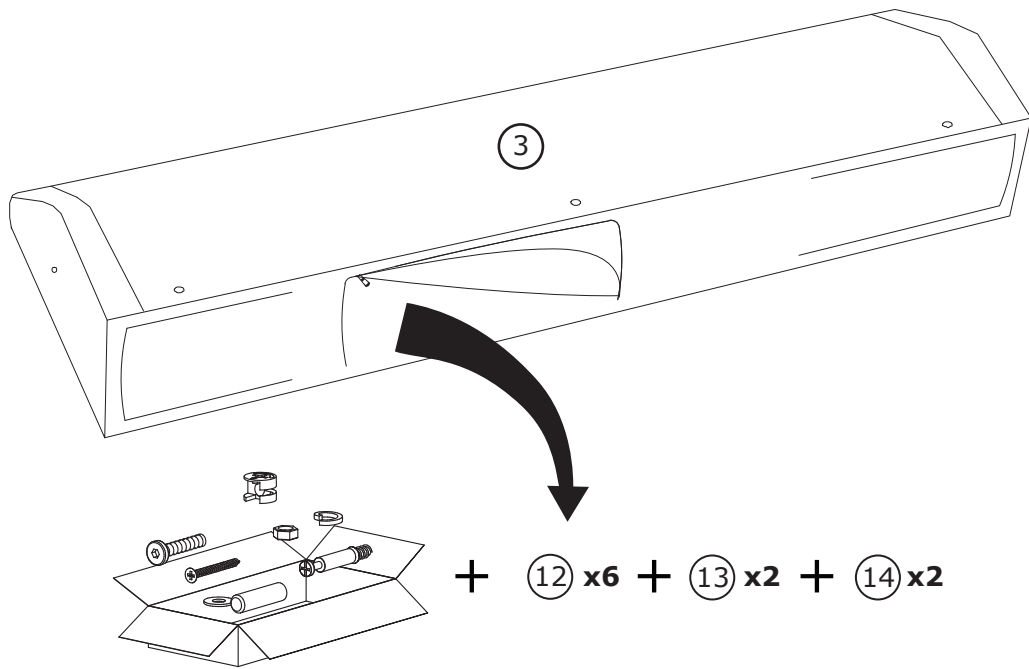

1

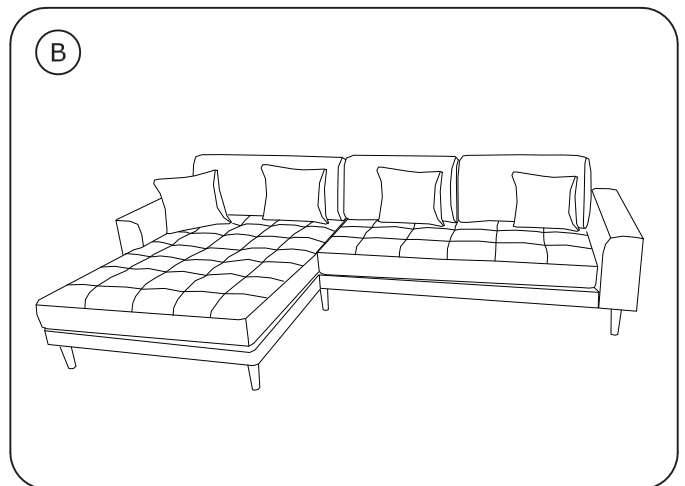
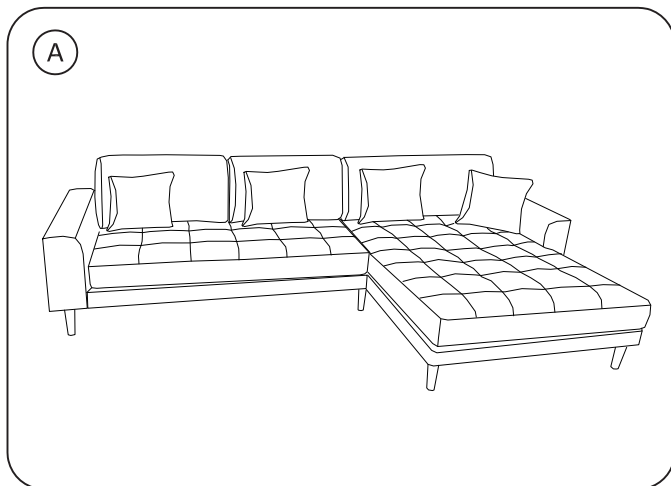
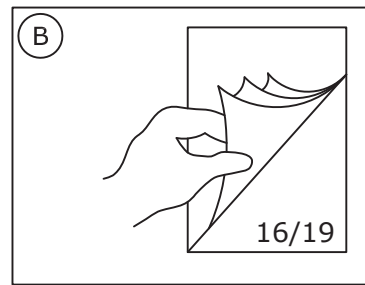
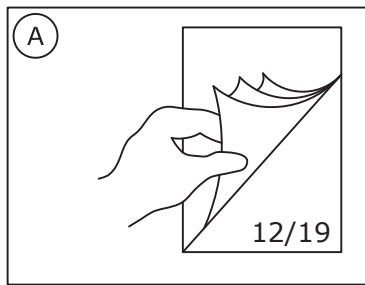

2



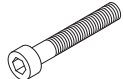
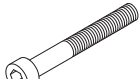
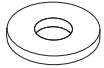

3

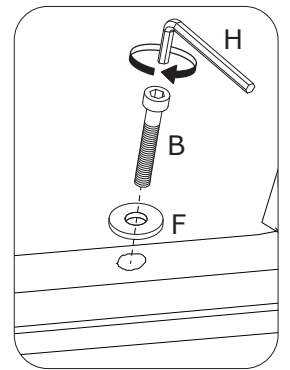
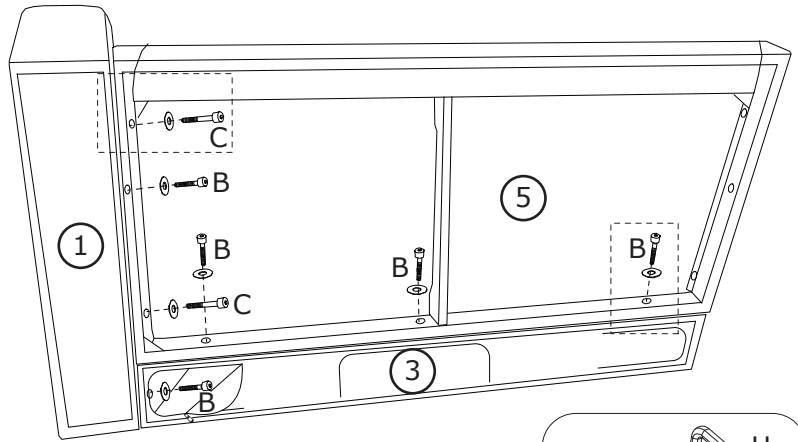
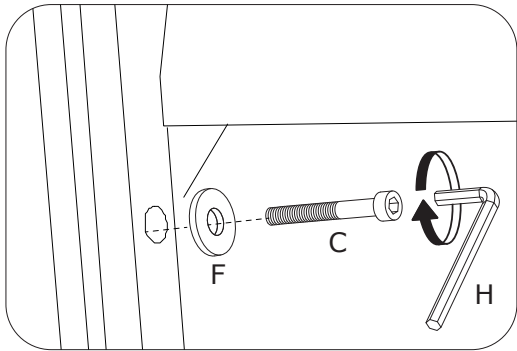
<p>B × 5</p>  <p>M8×50 mm</p>	<p>C × 2</p>  <p>M8×70 mm</p>	<p>F × 7</p>  <p>Ø8/Ø22 mm</p>	<p>H × 1</p>  <p>6 mm</p>	
--	--	---	---	--



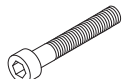
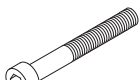
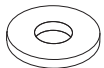

4

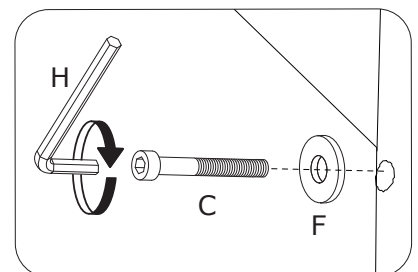
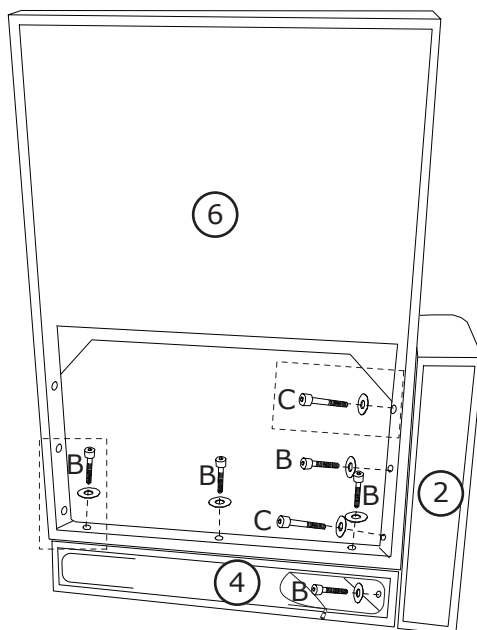
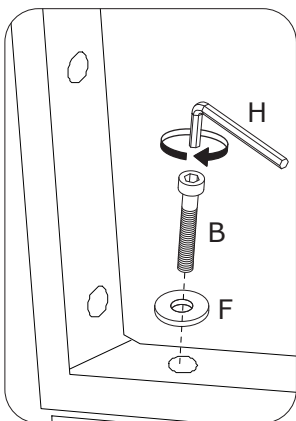
<p>B × 5</p>  <p>M8×50 mm</p>	<p>C × 2</p>  <p>M8×70 mm</p>	<p>F × 7</p>  <p>Ø8/Ø22 mm</p>	<p>H × 1</p>  <p>6 mm</p>	
--	--	---	---	--



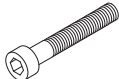
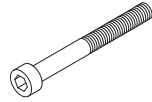

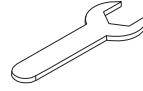
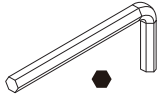
5

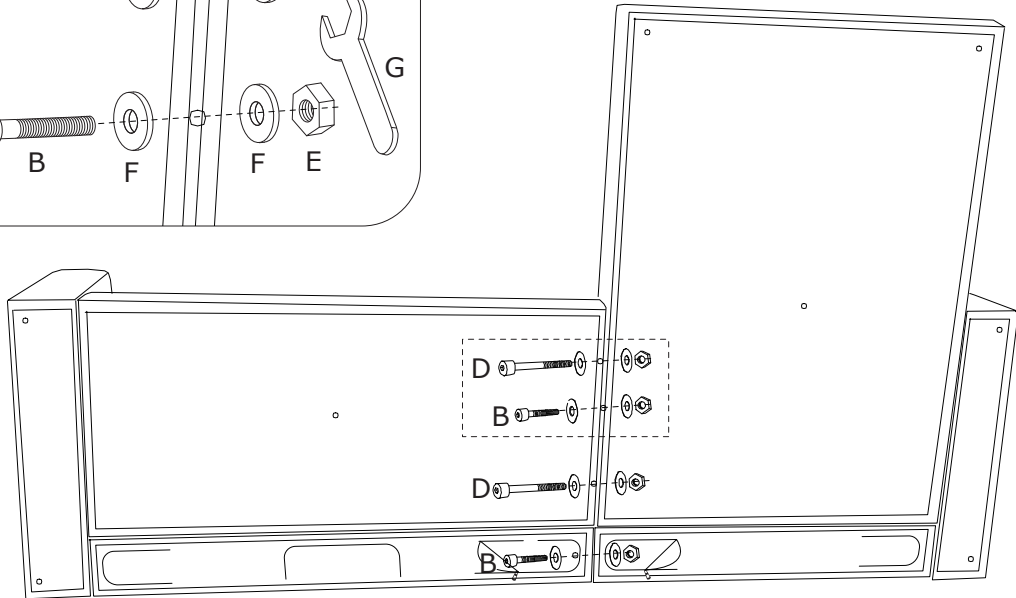
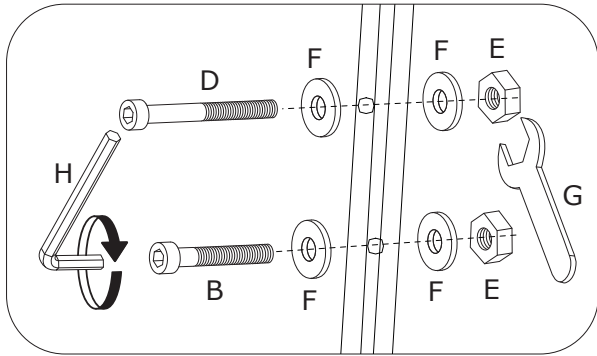
$B \times 2$  M8x50 mm	$D \times 2$  M8x120 mm	$E \times 4$  M8/14 mm	$F \times 8$  Ø8/Ø22 mm	$G \times 1$  14 mm	$H \times 1$  6 mm
---	--	---	---	--	---



6

$A \times 4$  M8x20 mm	$F \times 4$  Ø8/Ø22 mm	$H \times 1$  6 mm	
---	--	---	--

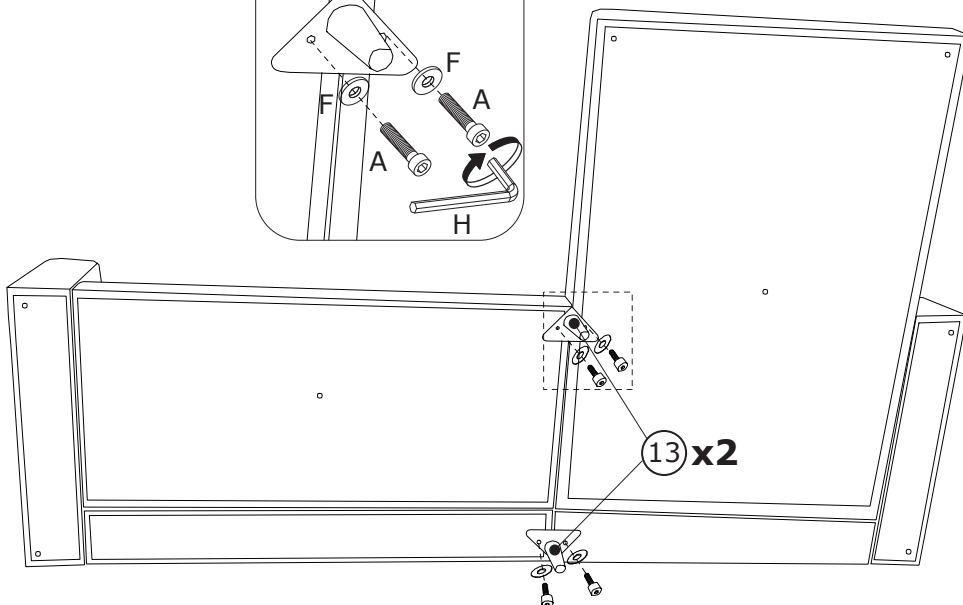
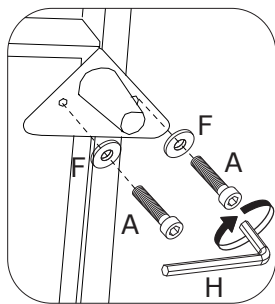

7

J x 8	
	
Ø12/Ø24 mm	

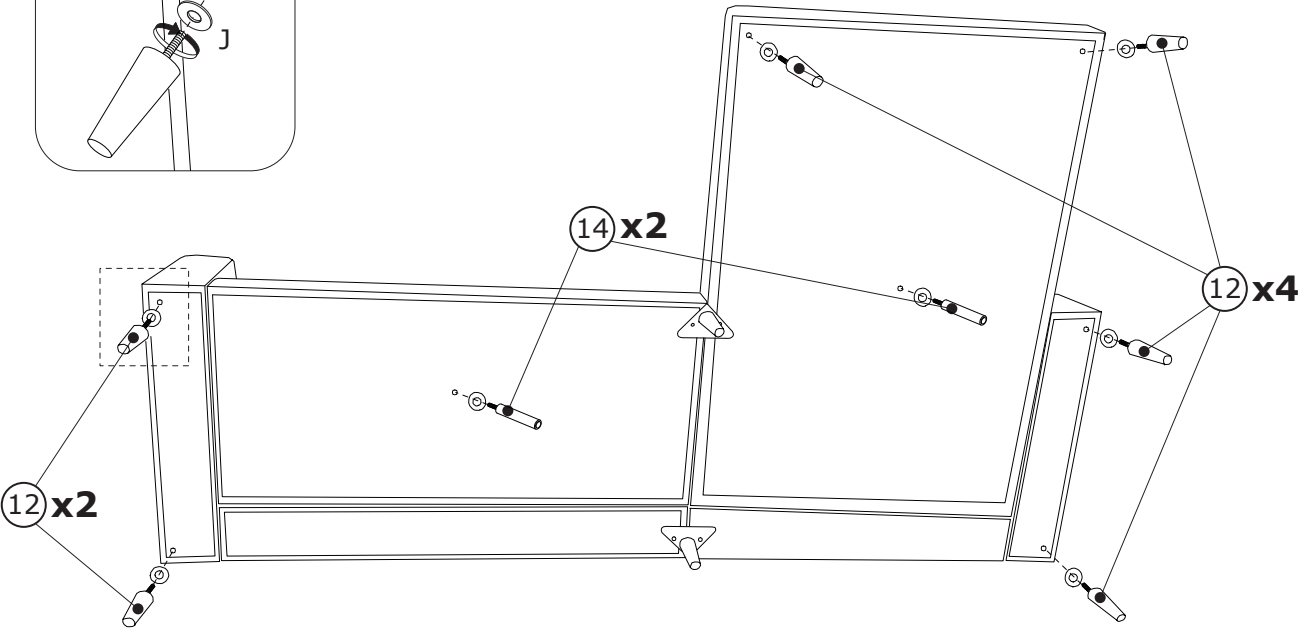
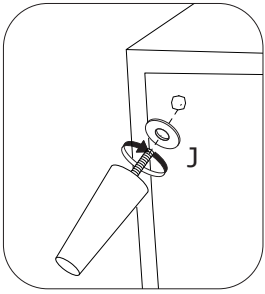

8

K x 8	
	
Ø25x3 mm	

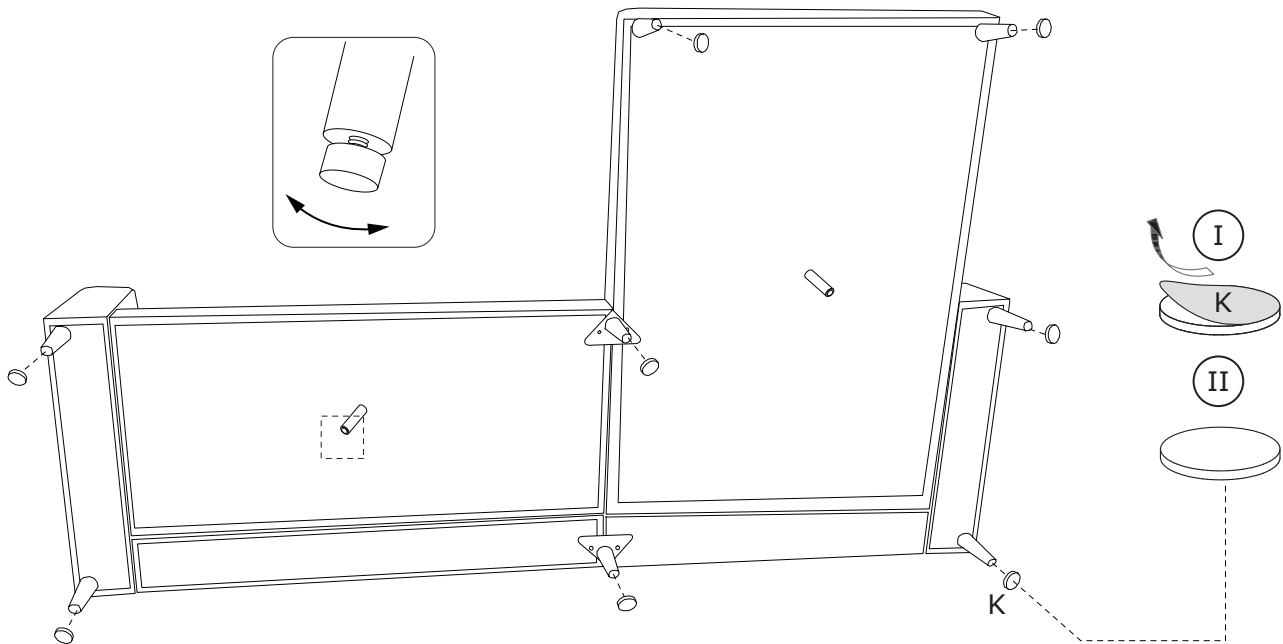
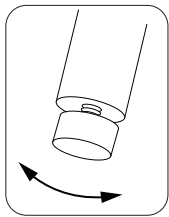

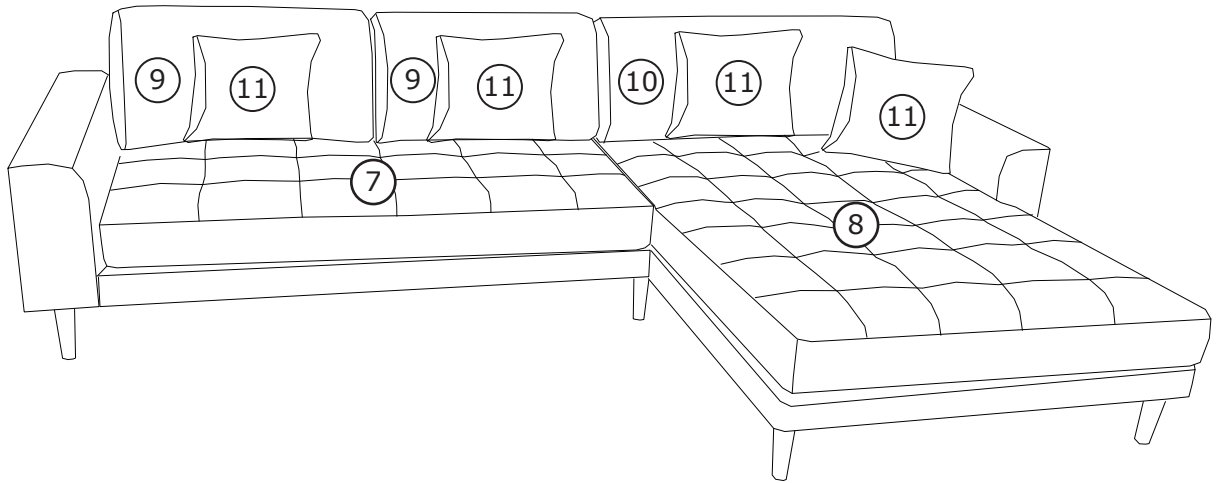

9

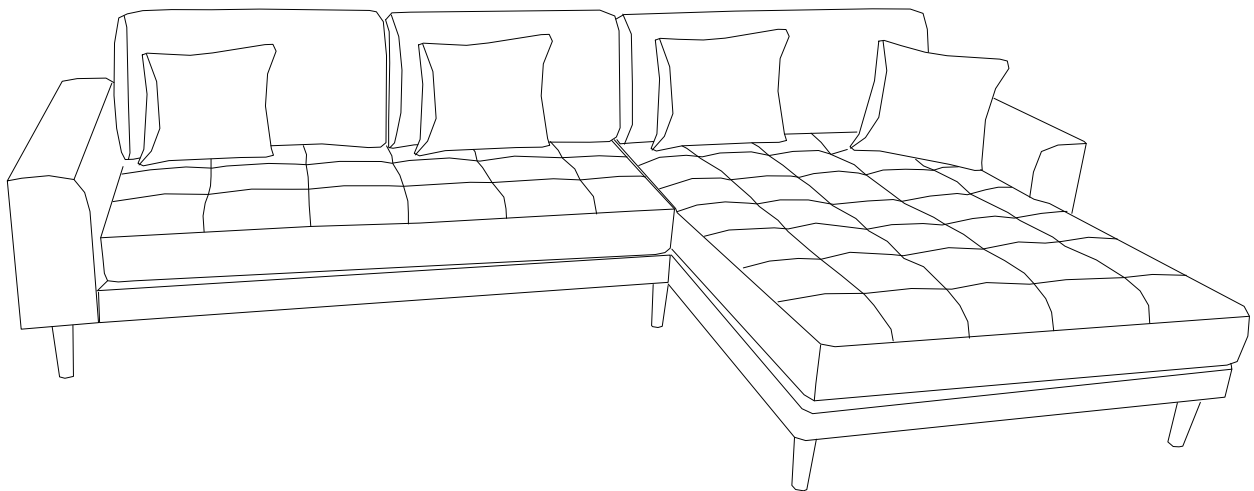

10



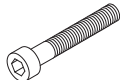
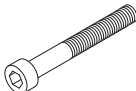

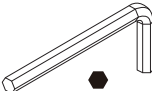
11

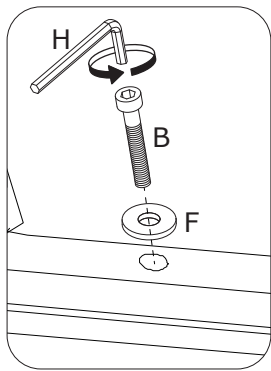
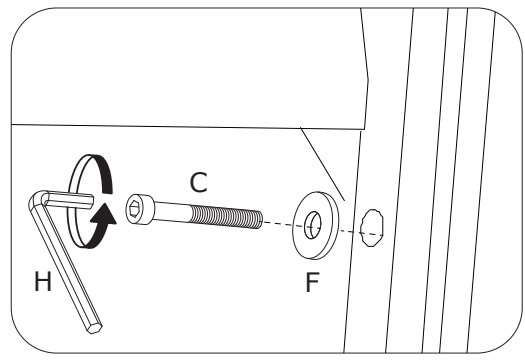
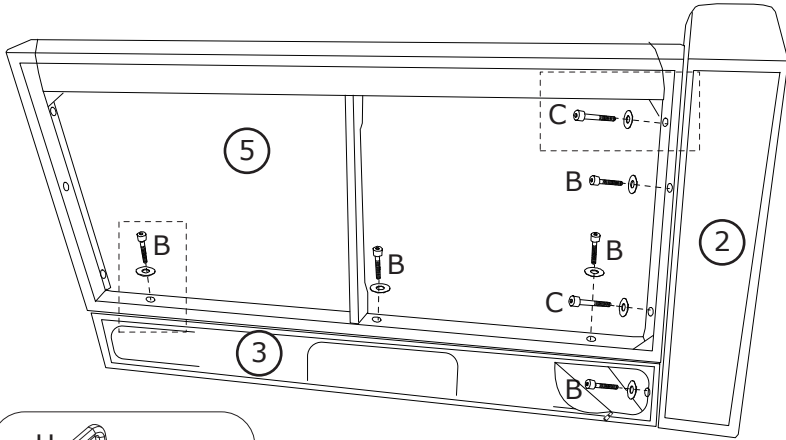
B × 5  M8×50 mm	C × 2  M8×70 mm	F × 7  Ø8/Ø22 mm	H × 1  6 mm	
--	--	---	---	--



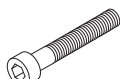
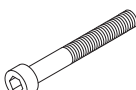

12

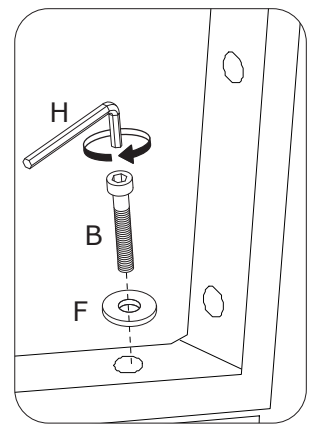
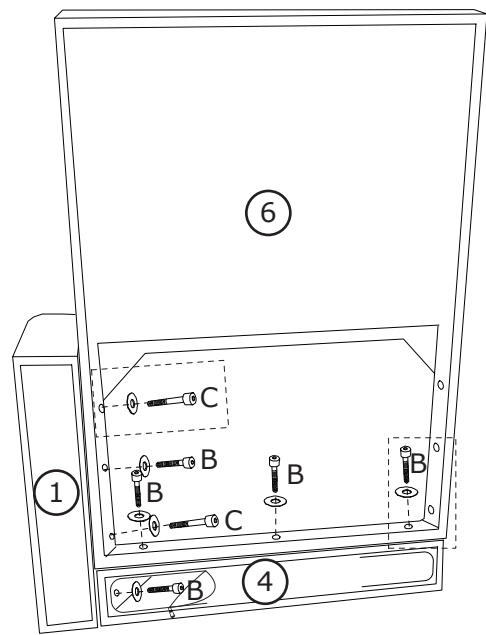
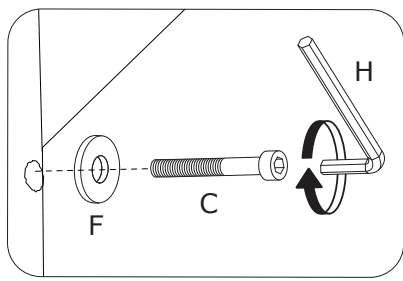
B × 5  M8×50 mm	C × 2  M8×70 mm	F × 7  Ø8/Ø22 mm	H × 1  6 mm	
--	--	---	---	--



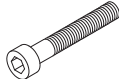
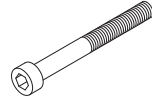

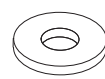
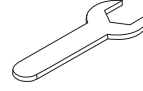
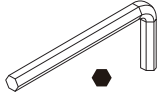
13

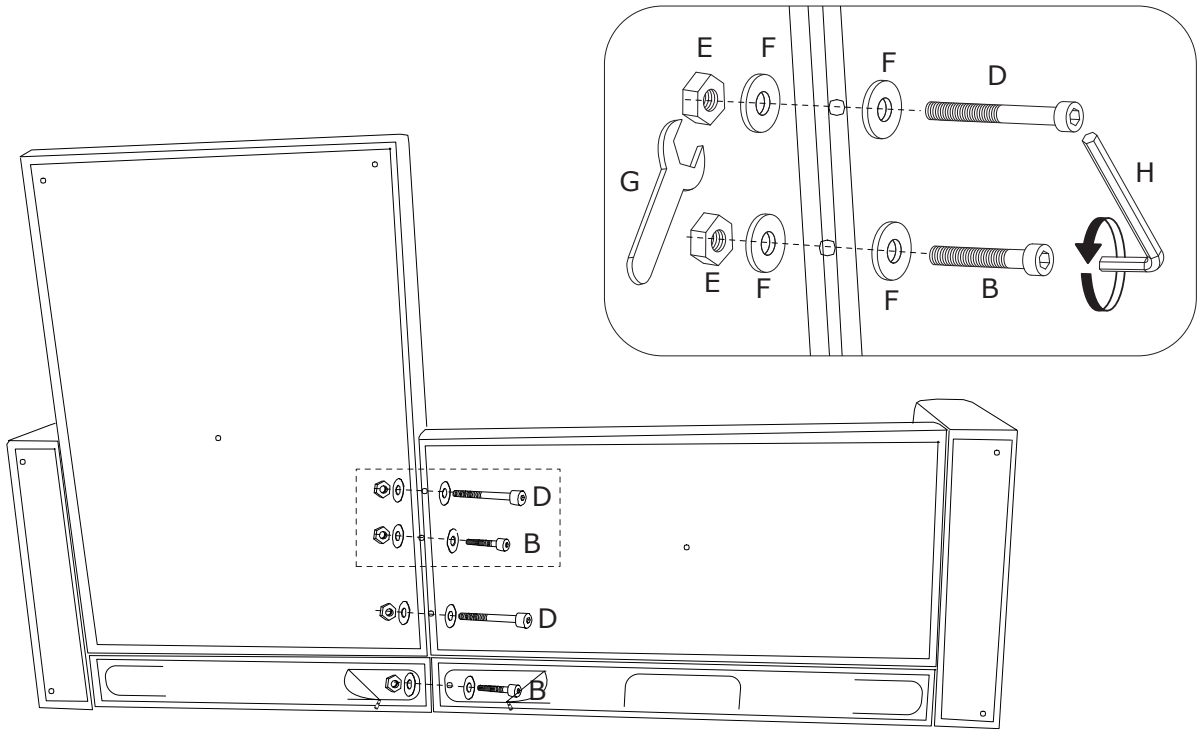
$B \times 2$  M8x50 mm	$D \times 2$  M8x120 mm	$E \times 4$  M8/14 mm	$F \times 8$  Ø8/Ø22 mm	$G \times 1$  14 mm	$H \times 1$  6 mm
---	--	---	---	--	---

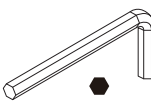

14

$A \times 4$  M8x20 mm	$F \times 4$  Ø8/Ø22 mm	$H \times 1$  6 mm	
---	--	---	--

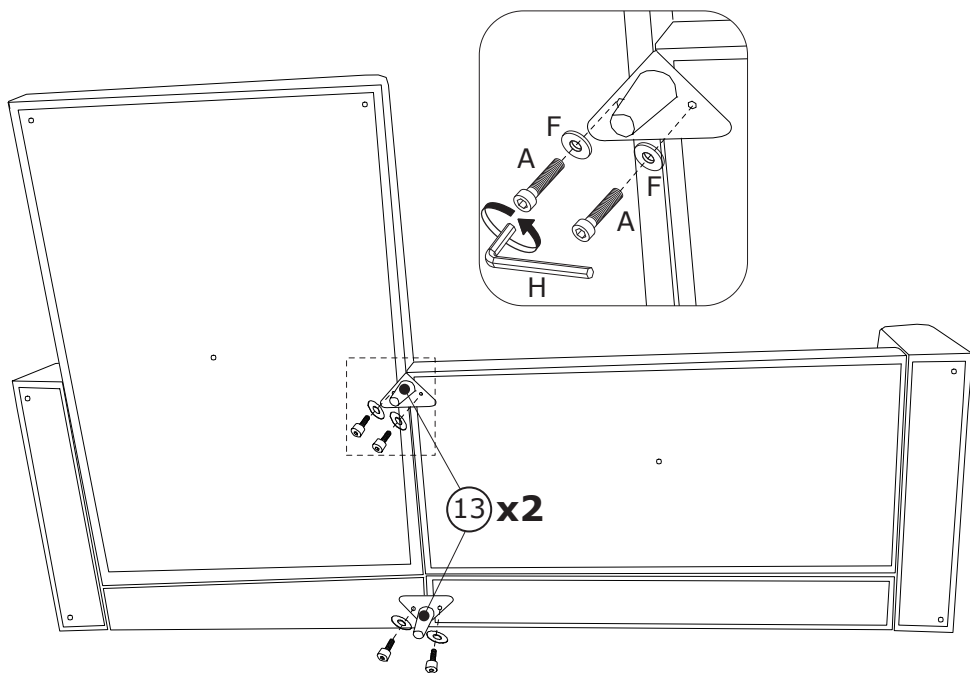

15

<p>J × 8</p>  <p>Ø12/Ø24 mm</p>	
--	--

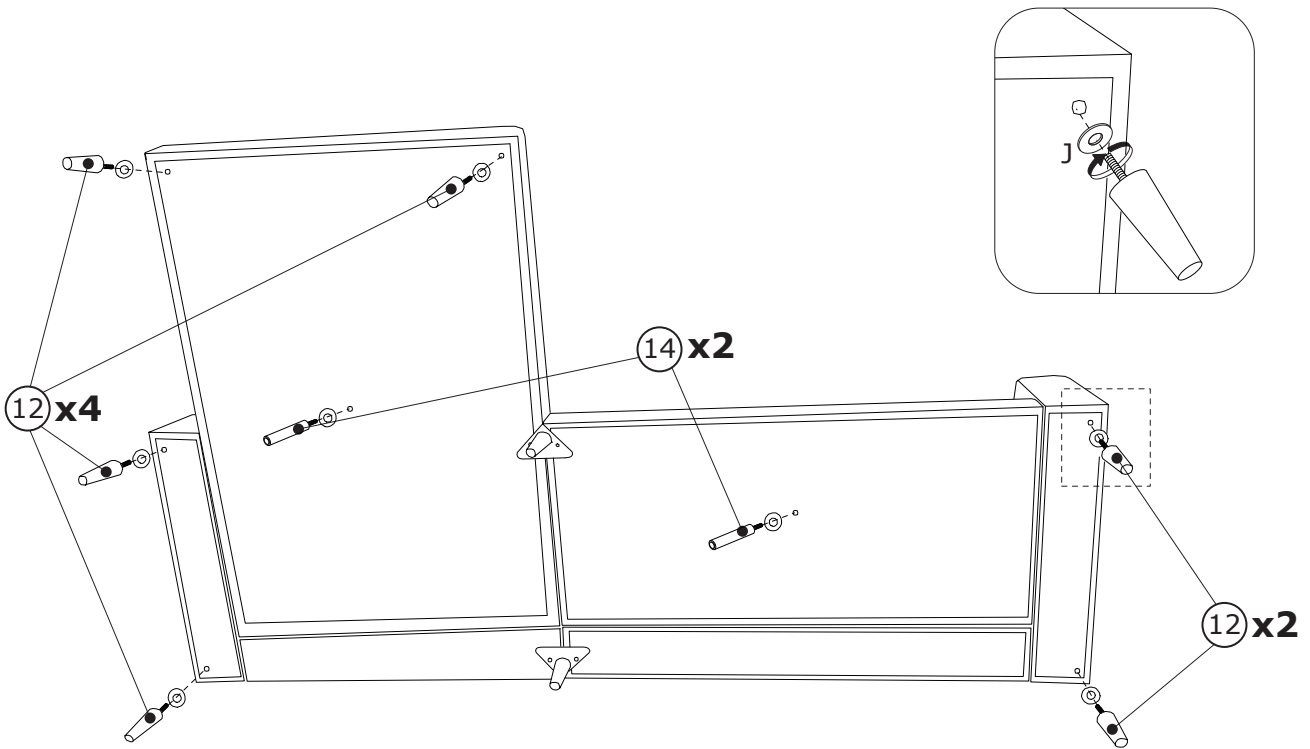

16

<p>K × 8</p>  <p>Ø25×3 mm</p>	
--	--

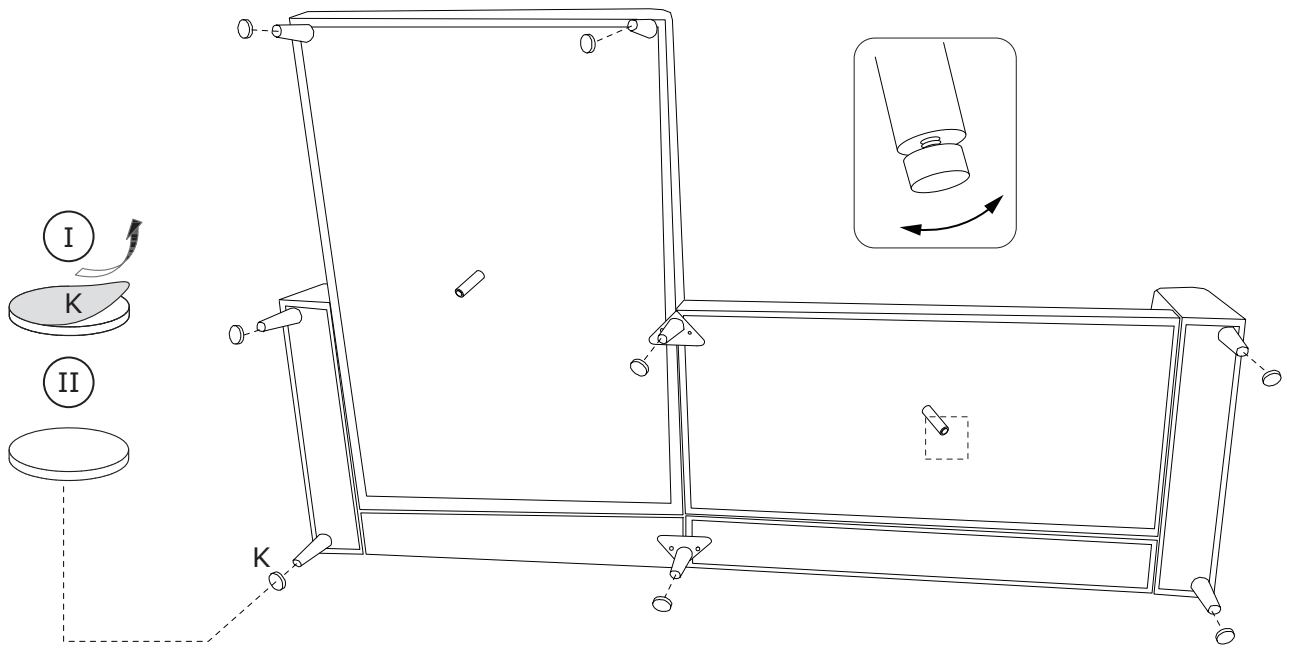

17

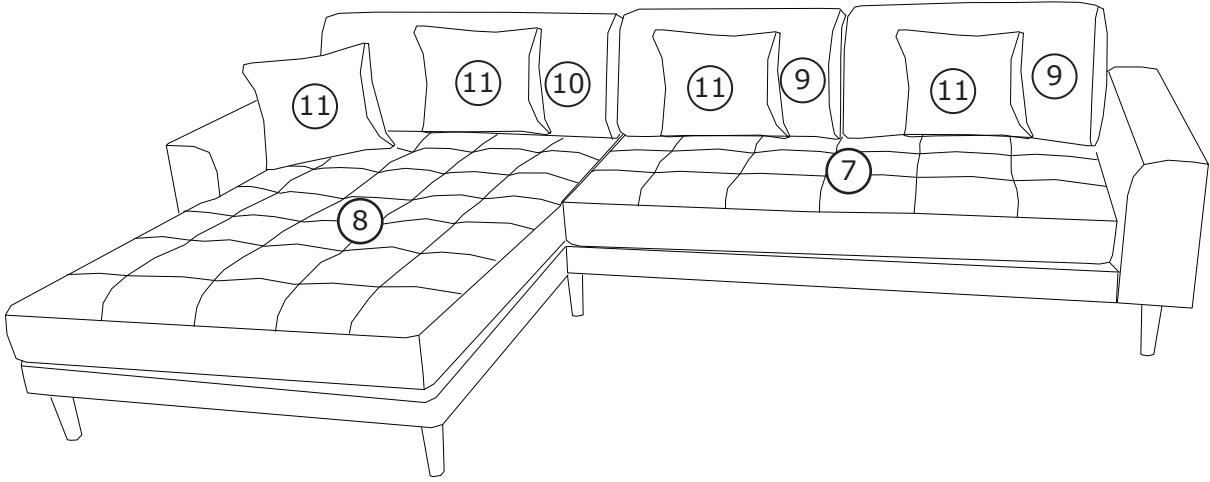

18

