

# ASSEMBLY INSTRUCTION (130-058)

## PARTS LIST

1. -1 Pc

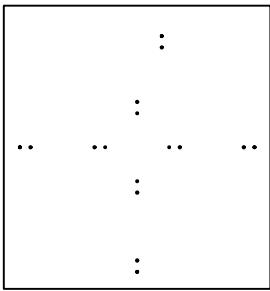

2. -1 Pc

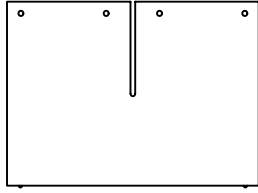

3. -1 Pc

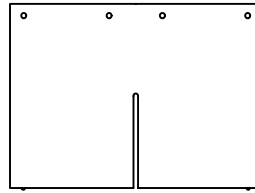

4. -4 Pcs

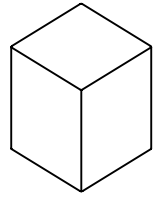

## FITTINGS

A. -8Pcs.



B. -8Pcs.



C. -8Pcs.



D. -1Pc.

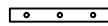

E. -3Pcs.



F. -16Pcs.



1.

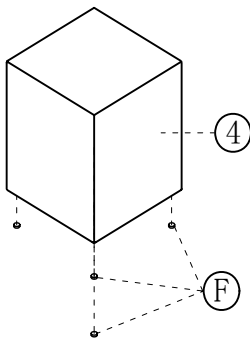

2.

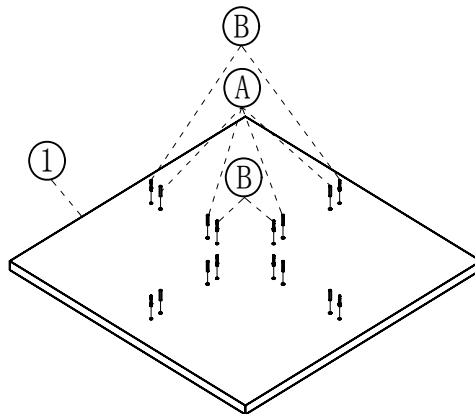

3.

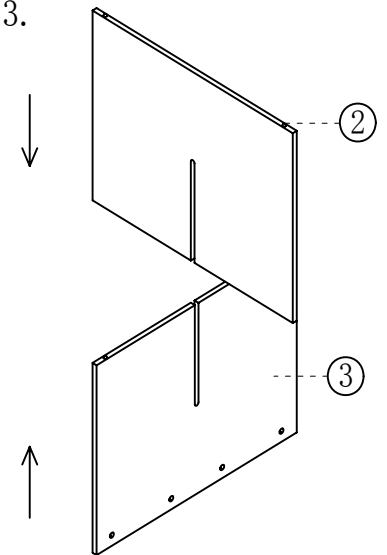

4.

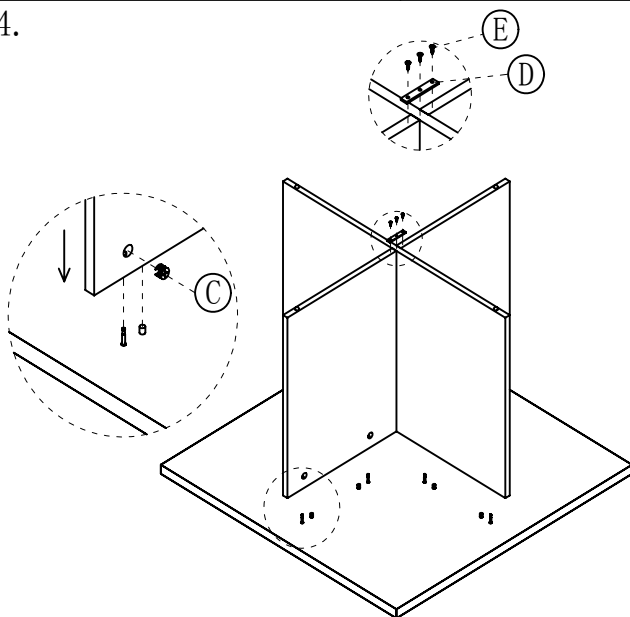

5.

