

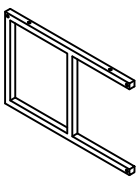









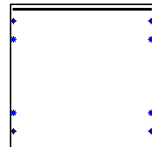
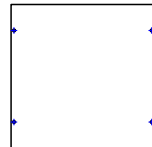
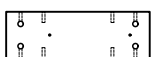
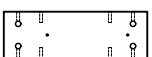

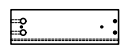
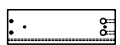
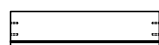

# ASSEMBLY INSTRUCTION (130-073)

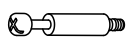
1. -2 Pcs 	2. -4 Pcs 	3. -1 Pc 	4. -1 Pc 	5. -1 Pc 	6. -1 Pc 
7. -1 Pc 	8. -1 Pc 	9. -1 Pc 	10. -1 Pc 	11. -1 Pc 	12. -1 Pc 

A -8 Pcs 	B -4 Pcs 	C -1 Pc 	D -12 Pcs 	E -12 Pcs 
F -8 Pcs 	G -8 Pcs 	H -4 Pcs 	I -2 Pcs $I = I_1 + I_2$ 	J -4 Pcs 

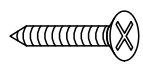
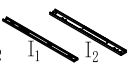

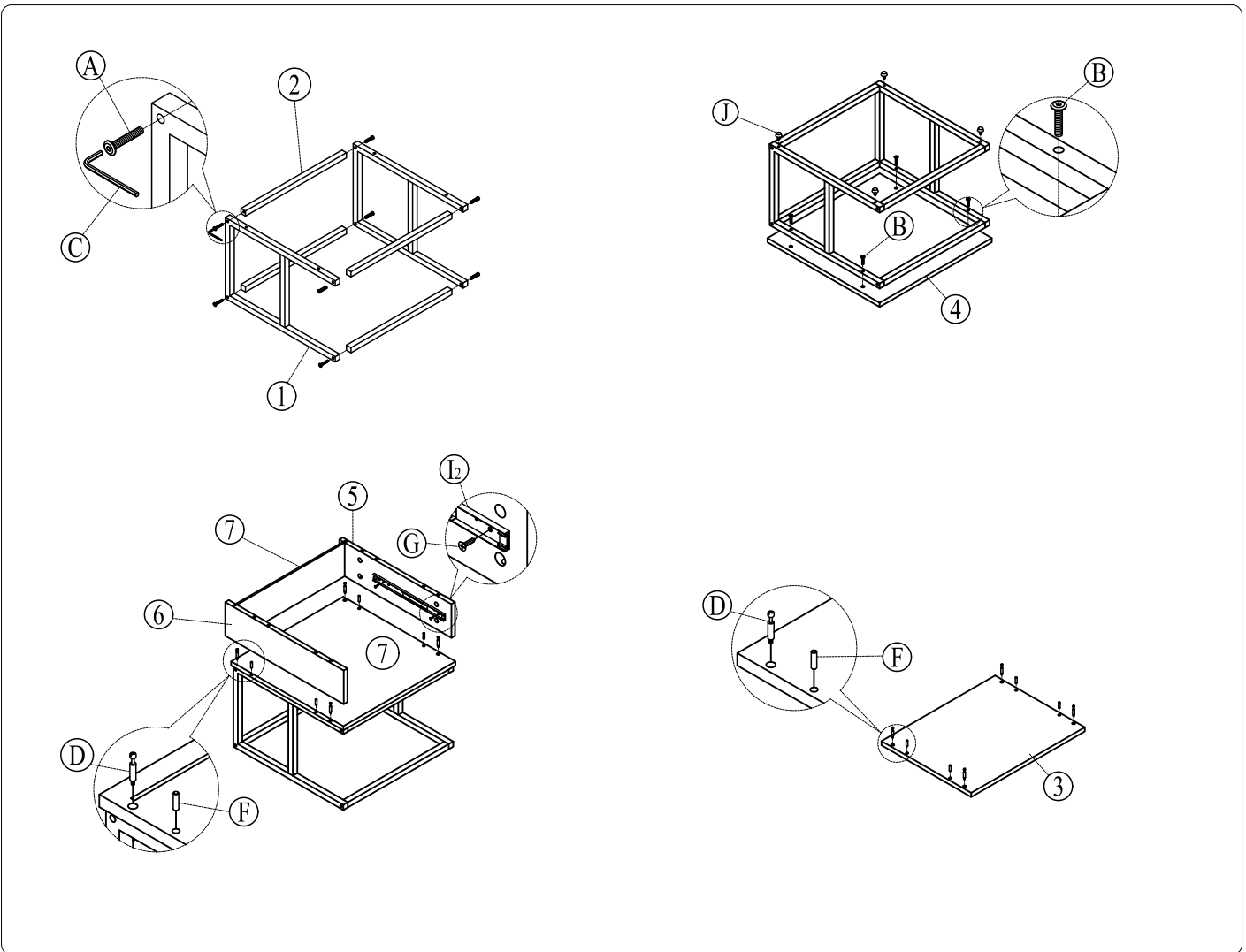
# ASSEMBLY INSTRUCTION

