

Assembly Instruction

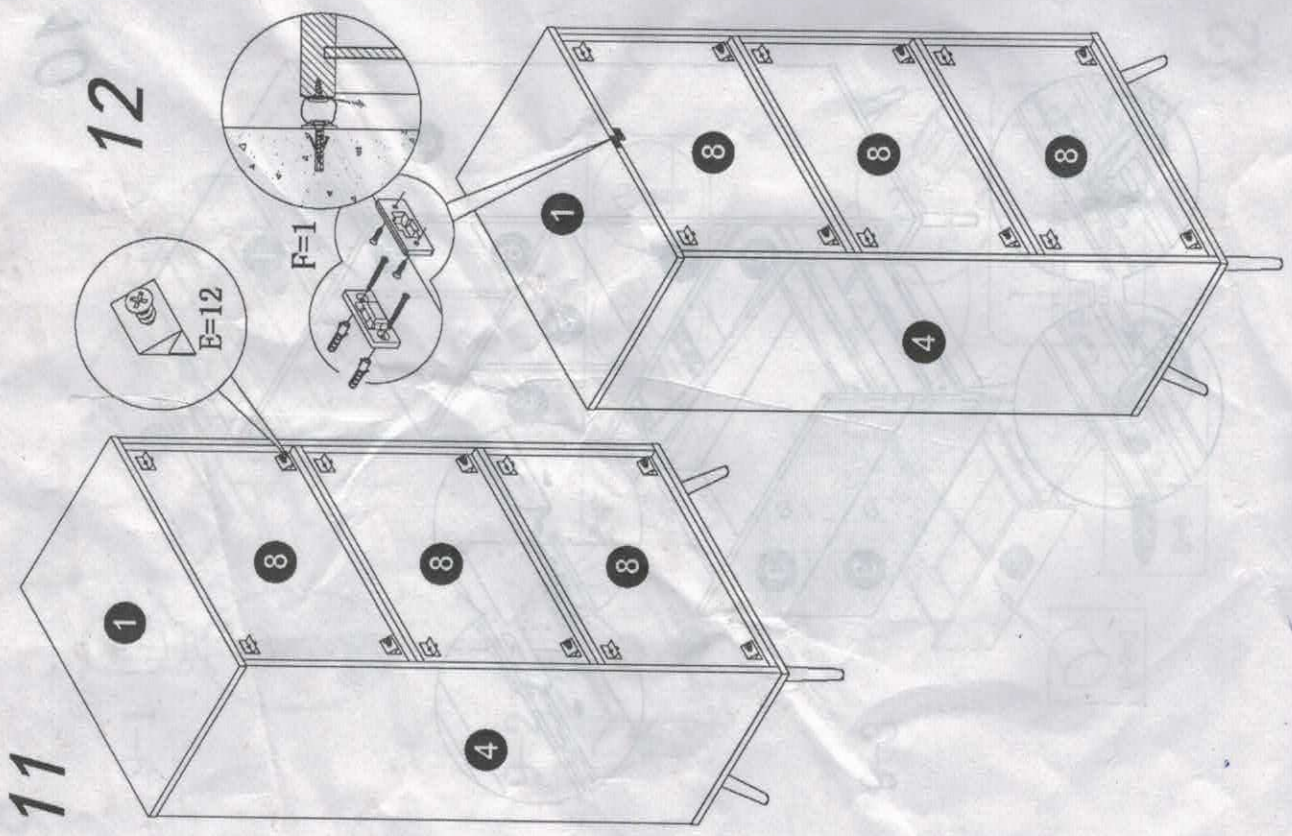

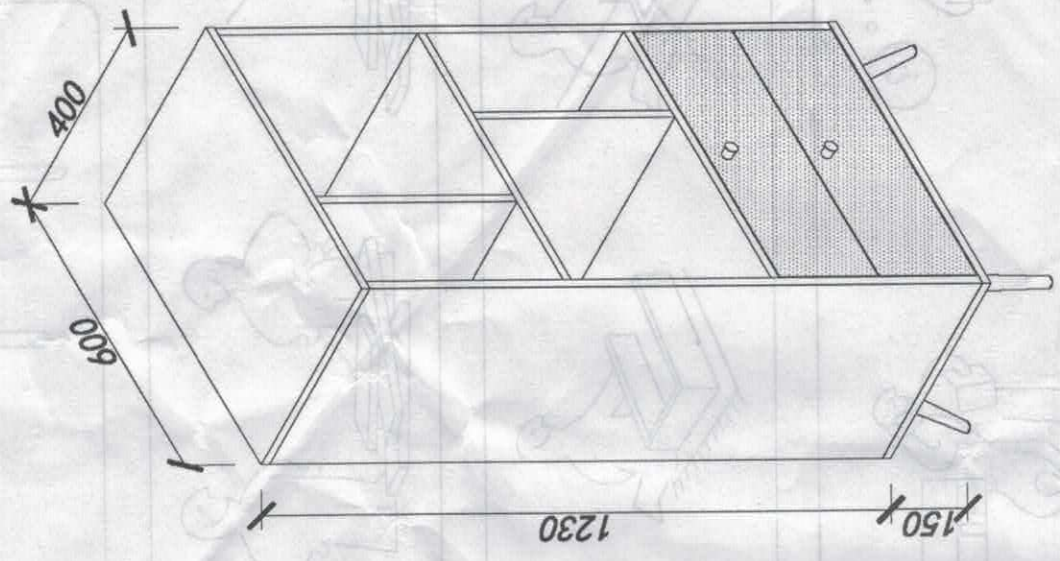
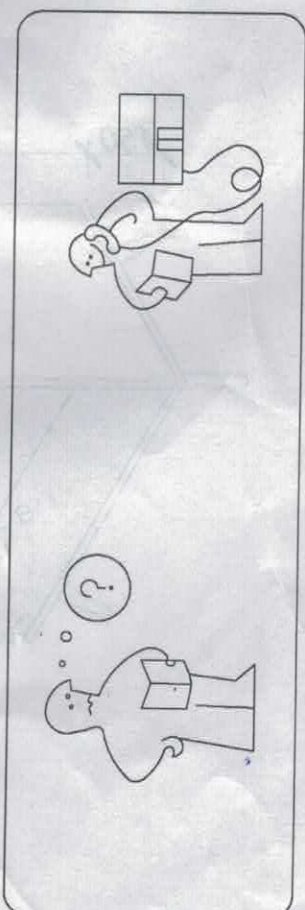
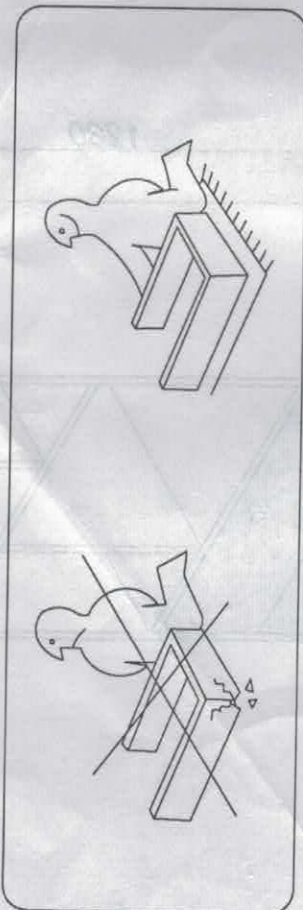
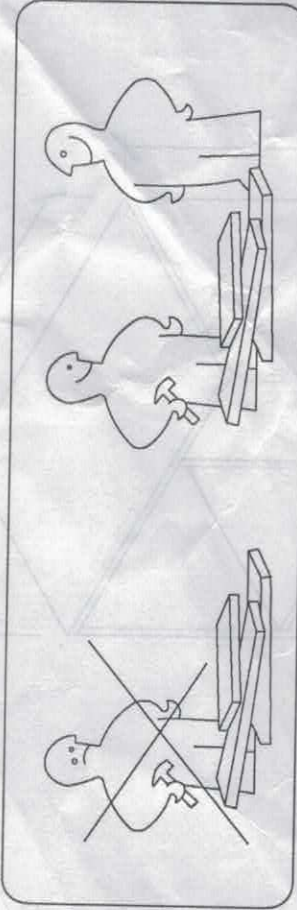
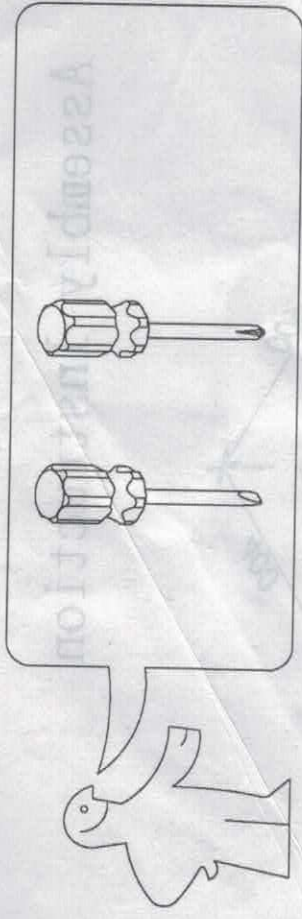

Panel No	Panel Sizes	Quantity
1	600*400*16	1
2	600*400*16	1
3	1198*399*16	1
4	1198*399*16	1
5	389*379*16	2
6	566*399*16	1
7	566*399*16	1

Panel No	Panel Sizes	Quantity
8	399*676*5	3
9	562*619*16	2
10	516*620*12	2
11	350*620*12	2
12	350*620*12	2
13	526*648*5	2

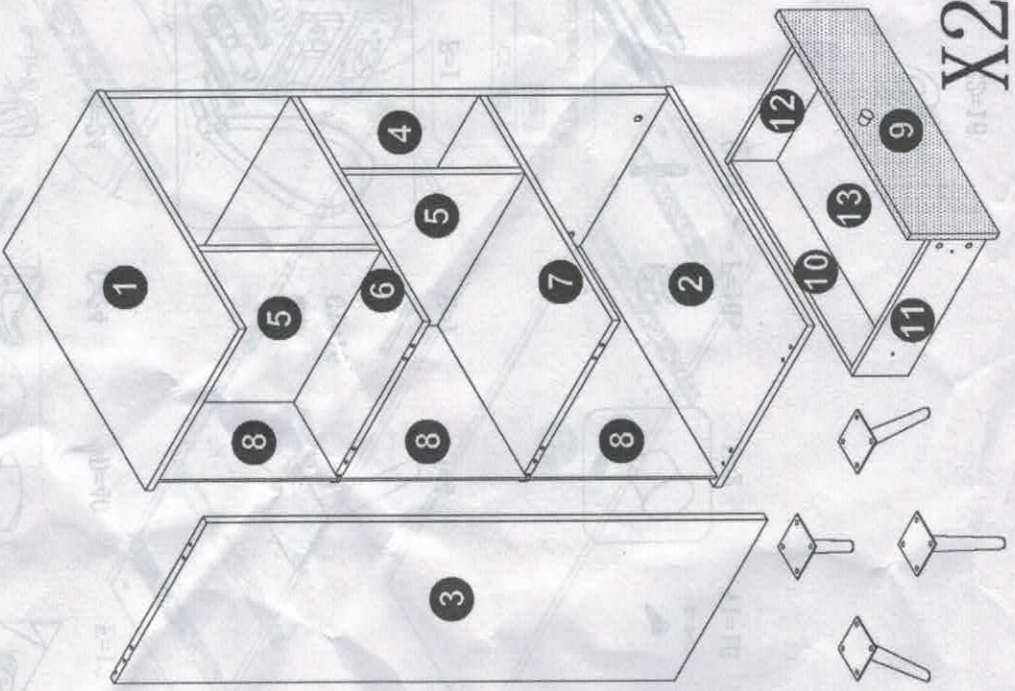

X2

Fittings



A=24

B=24



C=24



D=40



E=12

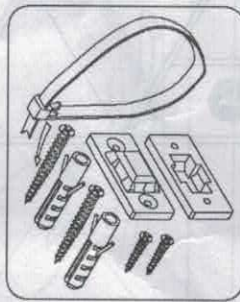

F=1



G1=16



H=1

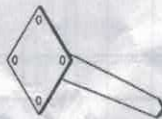

J=4



N=2



O=16



P=16



U=2



V1=16



Z1=16



Z2=16

1

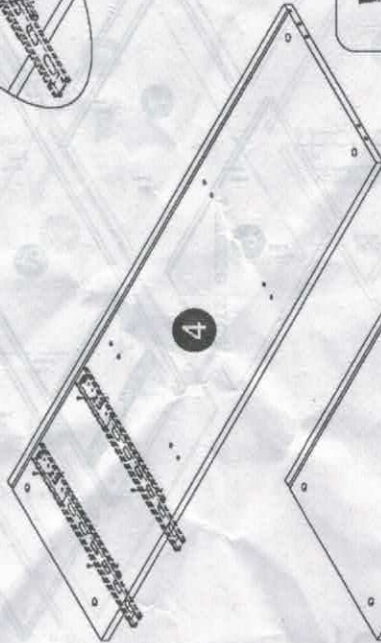
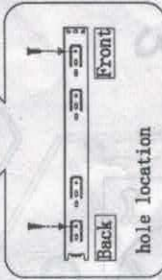
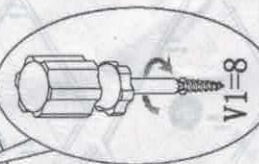
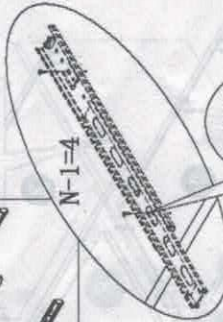
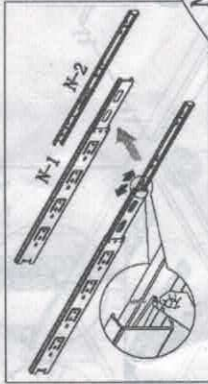

4

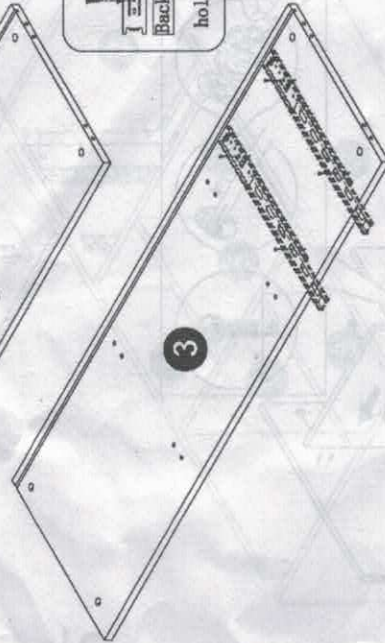

3

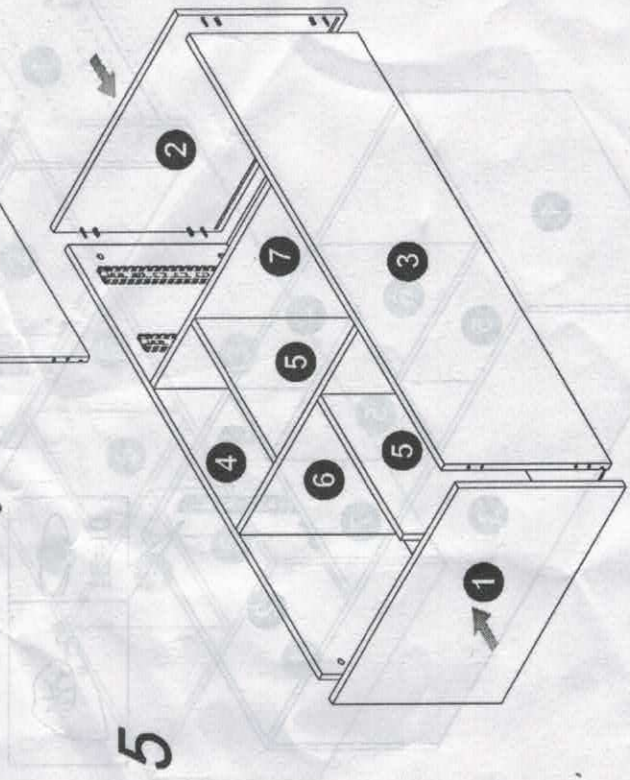
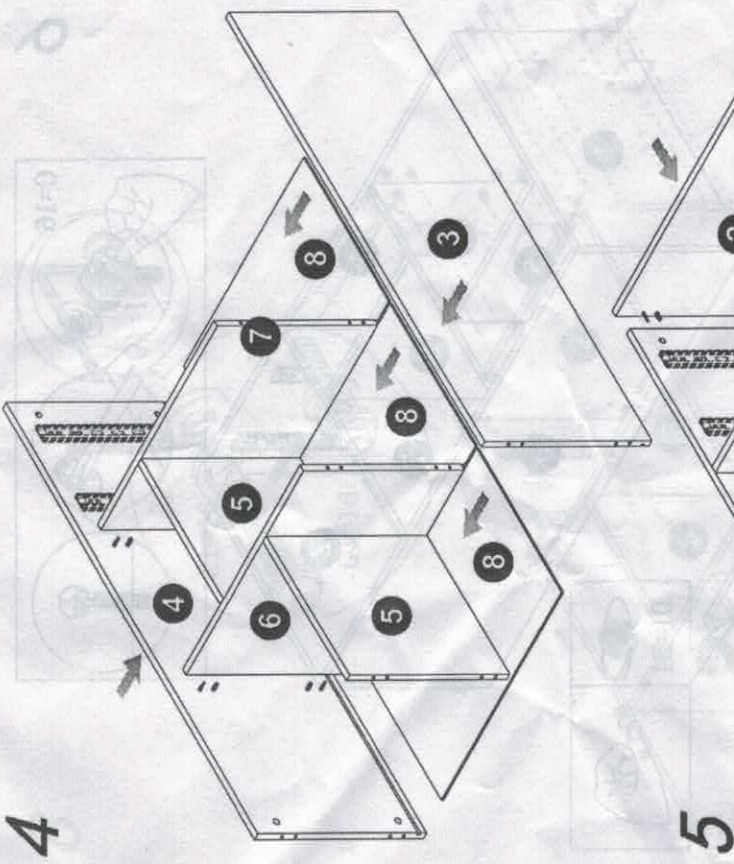
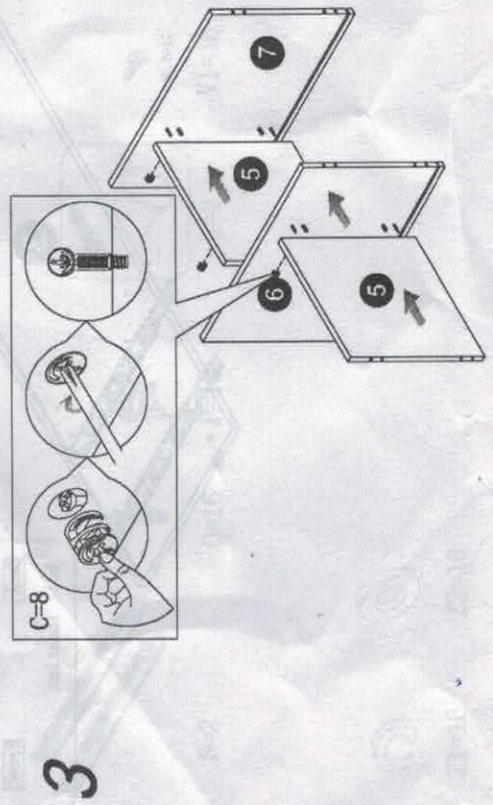
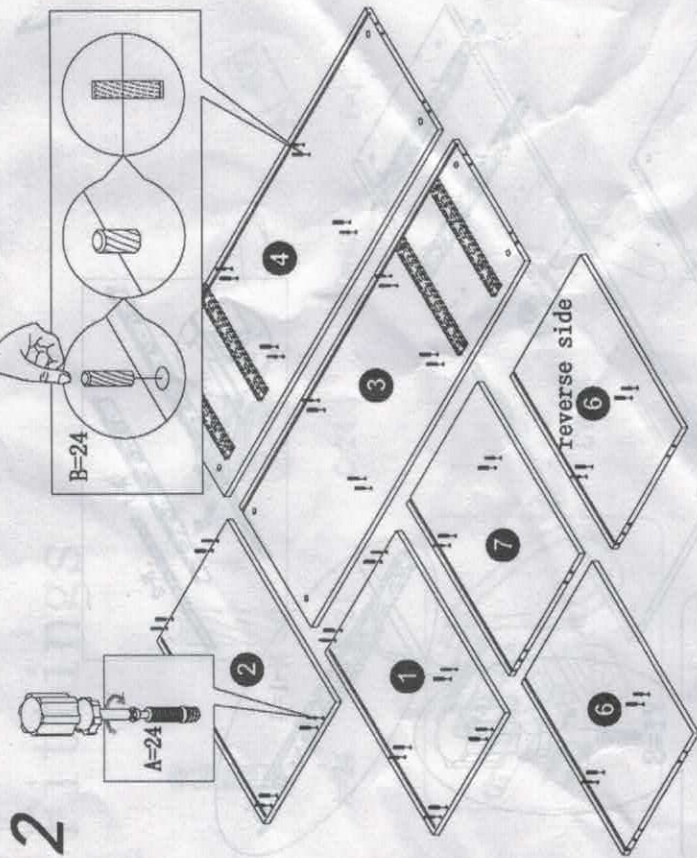

8

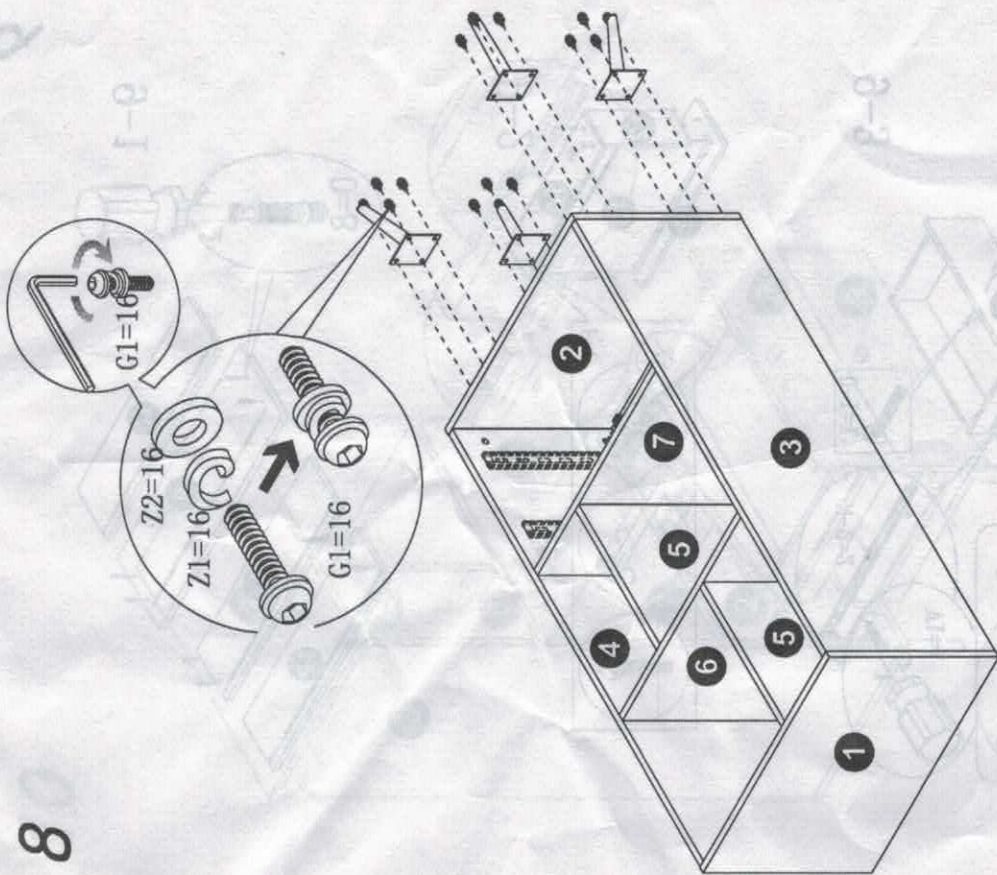

6

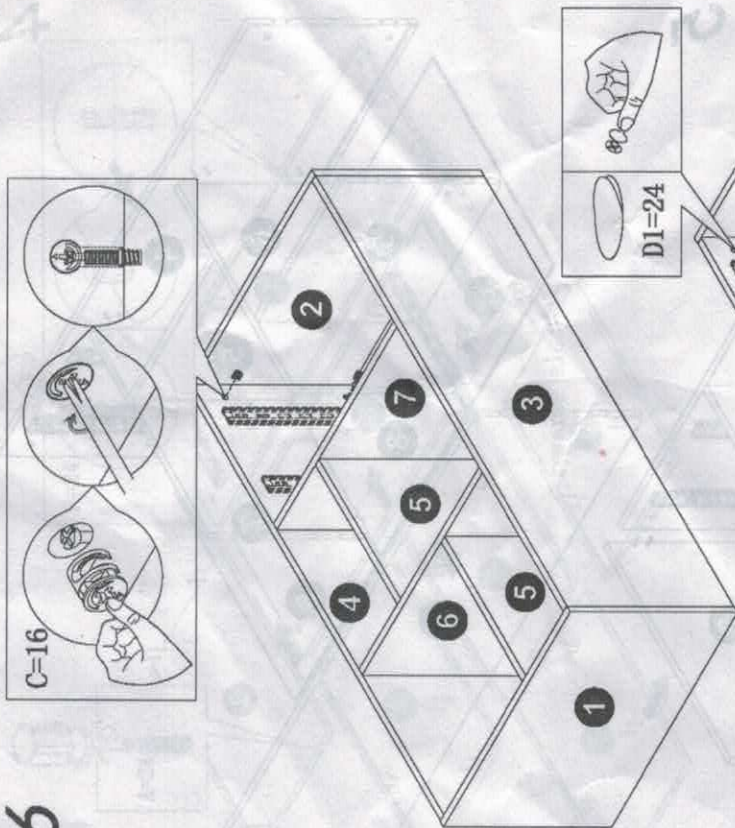

7

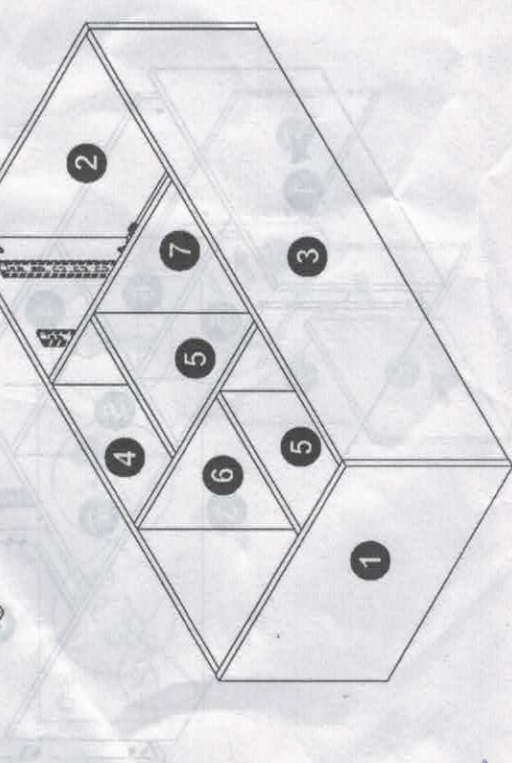

9

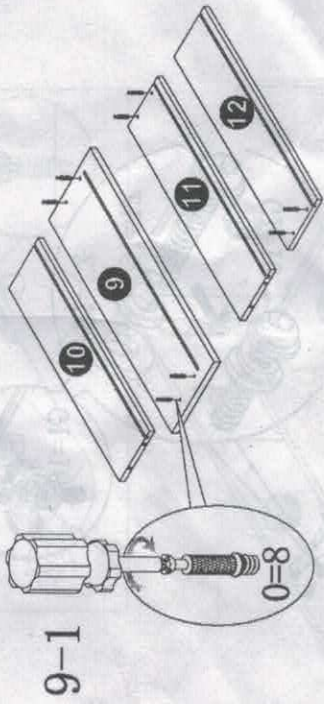

9-2

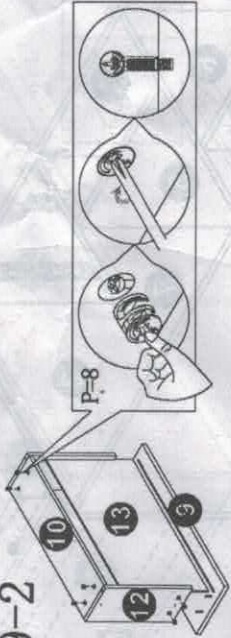

9-3

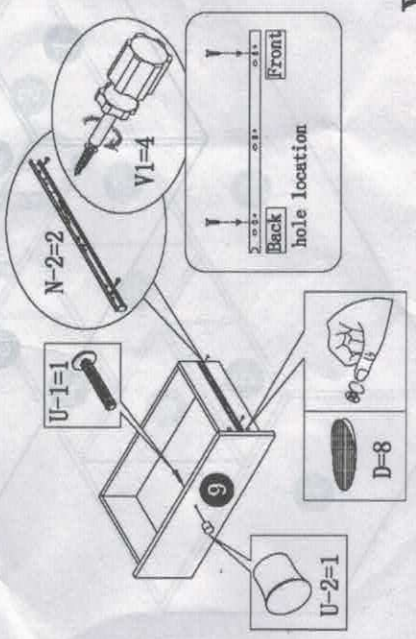

X2

10

