

Sunon 圣奥

Using instruction

Thanks for buying this product.
Please read this instruction carefully before using.

Product introduction

Series: UP1 series
Model: DZZ52-2.155154/DZZ53-2.155154
Name: L-shape lift desk
Dimension: 1450-1550*1440-1540*695-1185/605-1245
Lower frame color: Matt white, Matt black, Meteor grey
Material: fireproof veneer+ cold-rolled steel

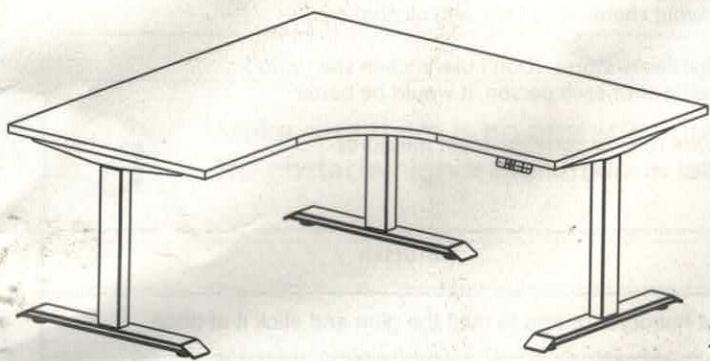

This product is used for office.
Decorations should be used indoor.

Zhejiang Sunon Furniture Manufacture Co., Ltd
Service Hotline: 4008-600-666
Website: www.sunon-china.com

Headquarters Address: Sunon Central Buisness Building, No. 200 Citizen Street, Qianjiang CBD, Hangzhou, Zhejiang
Manufacturing Base: No. 35, Ningdong Road, Economic and Technological Development Zone, Xiaoshan District, Hangzhou, Zhejiang
Manufacturing Base: No. 6, Anren Road, Jianshan Economic and Technological Development Zone, Haining, Zhejiang

Main feature

The product complies with following standards:

GB 18580-2017	Formaldehyde emission limit of interior decorating material artificial board and products made of it
GB/T 22792.1-2009	Office furniture screen part 1: dimension
GB/T 22792.2-2008	Office furniture screen part 2: safety requirements
HJ 2547-2016	Technical requirements of environment label products furniture
HJ 571-2010	Technical requirements of environment label products artificial board and products made of it.

Warranty:

Sunon strictly implements the national "three guarantees" policy (glass and mirror are not included).
The warranty lasts one year (specials are not included), responses will be given within 24 hours.

- The warranty is only valid in China.
- Damage caused by improper use is not covered by the warranty.
- Damage caused by fire or a natural disaster is not covered by the warranty.

Using instruction:

Please read this instruction carefully before using this furniture. To extend its longevity, please use and maintain it properly. Things of notice:

- Don't put furniture directly under sunlight or near AC vent or radiator to avoid color fading, shedding edge band or even distortion.
- Don't tilt desk or chair to avoid broken feet or loose connection.
- Don't put hot or icy objects directly on it to avoid color change or indelible marks.
- Don't push items on furniture directly to avoid scratches.
- Lift the furniture for about 10 mm off the ground when it has to be removed as a whole to avoid possible damages to the bottom and connector parts.
- It is suggested to put a soft cloth underneath if you want to lay heavy or hard items on the furniture.
- Use a soft cotton cloth or feather duster for cleaning and maintenance.
- Use detergent specially designed for furniture instead of chemical detergent or acid liquid for lampblack and other stain removal.

Simple malfunction analysis and solution

Remove stains

- paper mark: Immerse paper in salad oil and wait several minutes. Wipe the furniture with furniture-used steel wool along the grain and then polish.
- food stain: Stain of tea, vegetable, fruit, butter leaves slight traces on the surface and should be wiped out immediately.
- paint: For water-based paint, use soft and wet cloth to wipe it; for oil paint, let it dry up naturally and gently shave it with a blunt spatula or hard card.
- nail polish/nail polish remover: As chemical solvent, they should be wiped immediately.
- alcohol: If perfume/cocktail/medicine liquid spills out, let them dry up naturally.
- chewing gum: Shave it with blunt spatula or hard card after cooling it with ice bag or cold water.
- ball-pen/ink mark: Use soft eraser to rub it or sprinkle several drips of water. Avoid chemical solvent with alcohol or high corrosive ability.
- suggestion: Furniture-used steel wool can be bought at building material & hardware stores. (Don't use kitchen steel wool).
- note: The above suggestions may bring different results due to different operations of each person. It would be better if you can test it in inconspicuous area first.
- There may be cases as listed in the following list after long time of using. Please refer to correspondent measures.
- If your product is updated with new ones, please hand old products to qualified recycling companies.

malfunction	reason	solution
the banding edge is loose	environment	use hairdryer or iron to melt the glue and stick it at once
drawers can't be opened smoothly	lubricating oil is drying up	remove the drawer out, add lubricating oil or wax to the slide
uneven desktop	the adjustment leg is not properly adjusted	adjust it accordingly
sliding door slides out of the side panel	sliding door positioning parts are loosing or sliding door top bead slides down	return the sliding door positioning parts and sliding door top beads to original positions

Assembly instruction:

- Please determine the location of your furniture before assembly to avoid moving them for a large distance after being assembled.
- Do not place your furniture in dark and damp or hot and dry environment.
- Please check the number of packaging bags, view the product installation manual and verify the product structure.
- Please check the direction of each part when unpacking them before installation.
- Please install the product patiently. Make sure each part is in the right position. Furniture is easy to assemble, but it needs patience and care to make every part in place.
- Please check the stability of the furniture after installation. Shake your furniture gently to confirm whether it is level with the ground or whether the screw is tight.
- Please keep the furniture open for a period of time to release residual painting smell.

Note:

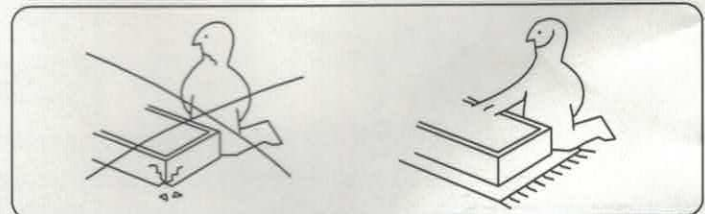
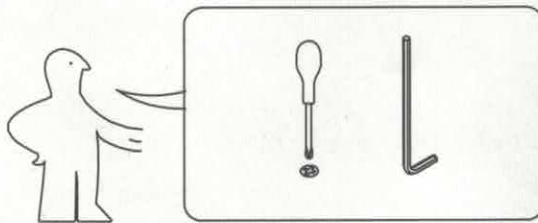

② Handle it with care. Use a protective layer.

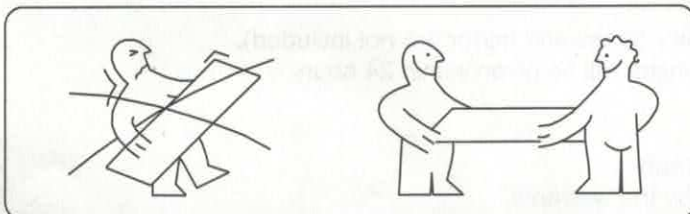

① Move it carefully with at least 2 people.

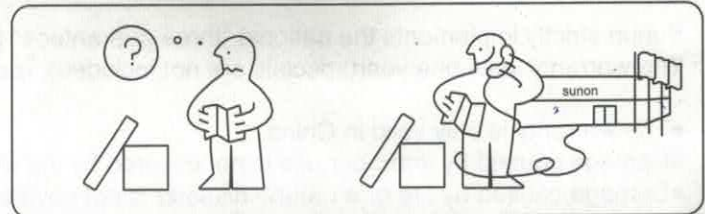

③ Contact Sunon if you have any questions.

Caution



Make sure children and pets are away from the product when it is operating. Please unplug it when there is thunder and lightning or long-time no-use.



Make sure there is a gap between desk and wall.



Make sure there is no obstacle during operation.
No obstacle higher than 500mm is allowed under the desk.



Working temperature is 0-40 degrees. The product should be away from erosive gas, liquid or dusty objects.



Disassemble the product yourself may cause a malfunction to product and cause a damage to human body.



To avoid unnecessary damage to human body, make sure your hands and other body parts are placed at safe positions during operation in spite of the anti-bumping function of this product. When reset manually, this function won't be activated.



Please read instructions carefully before using this product.
We won't take responsibility for product damages or human injuries caused by improper operations.



When use it for the first time, or use it after a power-off, please reset manually and after that carry out relevant operations.

Accessory list

30 min

Time period

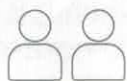

Personnel

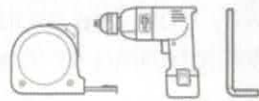

Tool

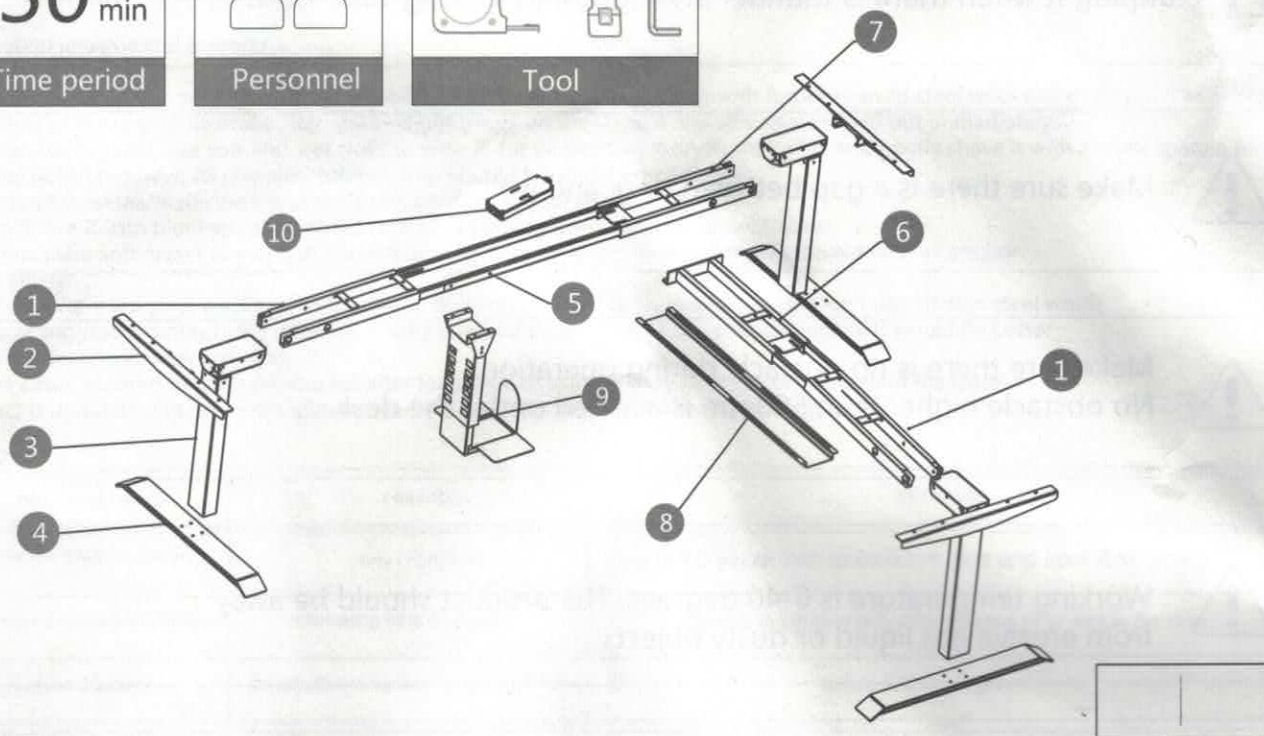

No. 5 hexagon wrench (standard)

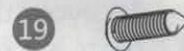
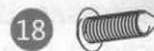
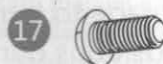
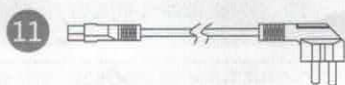

No.	Component	Amount(PCS)
1	frame1(with holes)	2
2	side panel	3
3	lifting standing pole	3
4	feet	3
5	connecting pole	4
6	frame2	1
7	frame3	1
8	wire supporter	1
9	mainframe supporter(optional)	1
10	N3controller	1
11	power cord	1
12	hand controller	1

No.	Component	Amount(PCS)
13	wire clip	20
14	soft rubber mat	17
15	extension wire	2
16	M6x10hexagon flat round head screw	32
17	M6x14hexagon flat round head screw	36
18	ST4.2*16 tapping screw	2
19	ST5*20 tapping screw	18

Assembly instruction

STEP 1

- Use four M6*14 hexagon flat round head screws to fix standing pole and bottom feet(12pcs)
- Use four M6*10 hexagon flat round head screws to fix standing pole and frame(12pcs)

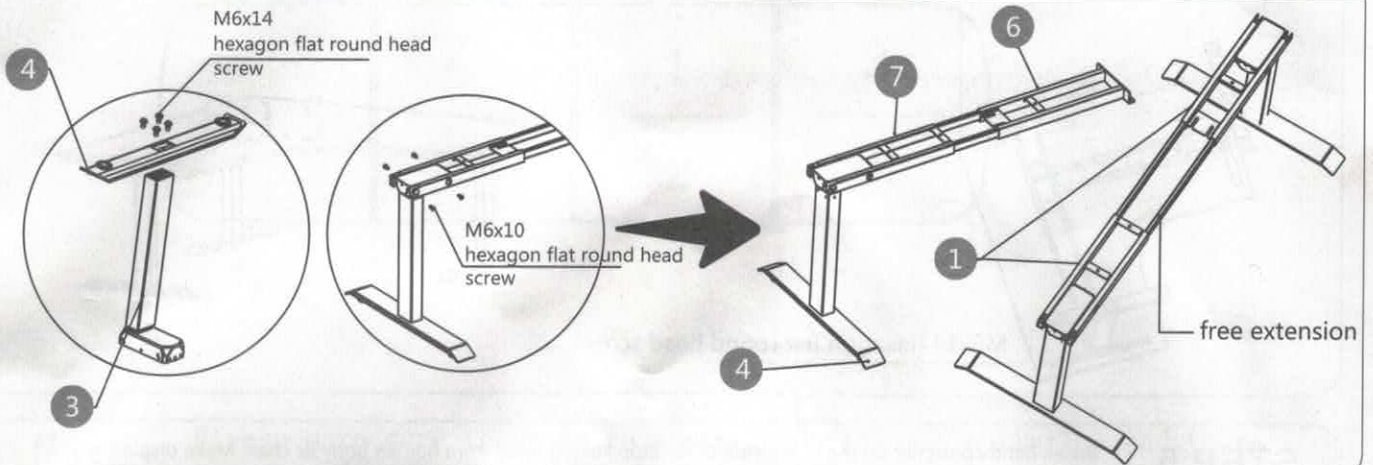

STEP 2

- Insert side board into frames , use 2 M6*14 hexagon flat round head screws to fix it with frame(6pcs) ;
- Use four M6*10 hexagon flat round head screws to lock frame2 and frame 3.

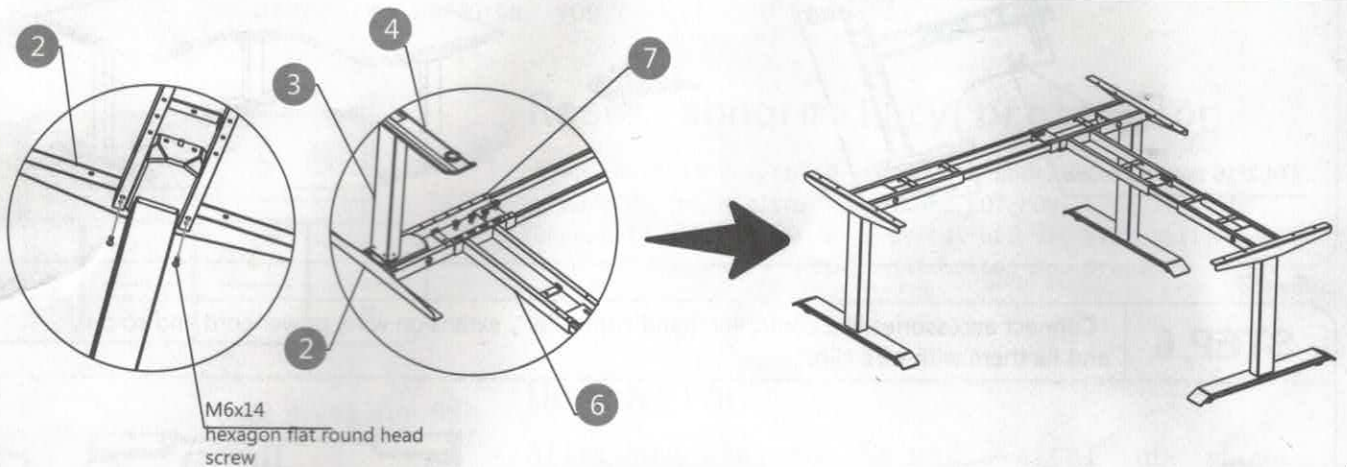

STEP 3

- Based on desktop dimension , extend frame to appropriate range.
- Use eight M6*10 hexagon flat round head screws to tighten frame and connecting pole.(16pcs)

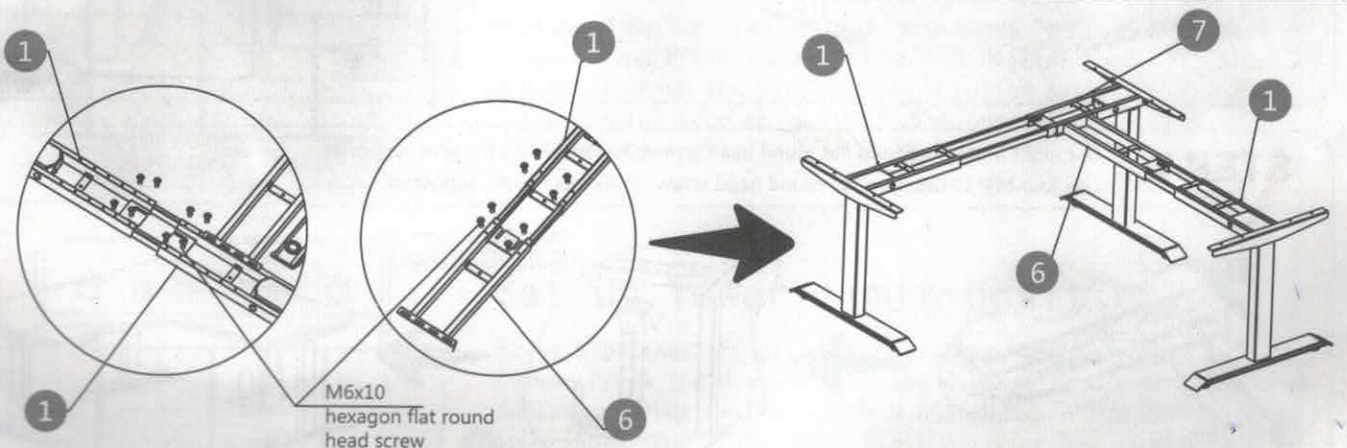

Assembly instruction

STEP 4

· Place already-checked desktop bottom under frame and adjust it to the central position, pre-fix screws on the frame. Use M6x14 hexagon flat round head screws to tighten it (put soft cushion between desktop and frame, all together 18 screws).

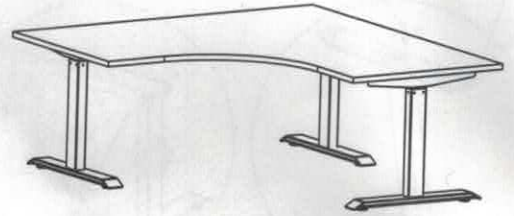
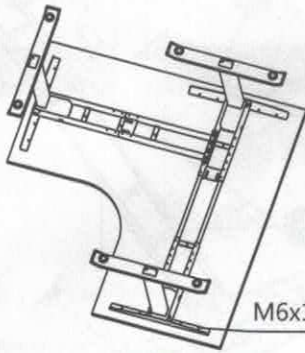

M6x14 hexagon flat round head screws

STEP 5

· Install hand controller on the either side of desktop, keep it away from human body or chair. Make display screen outwards. Use two ST4.2*16 tapping screws to fix it. Insert controller into the installing pieces.

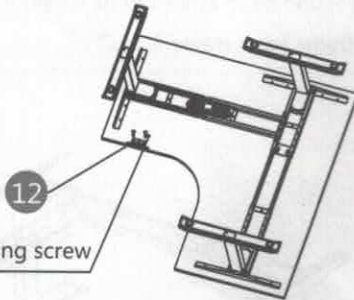

12
ST4.2*16 tapping screw

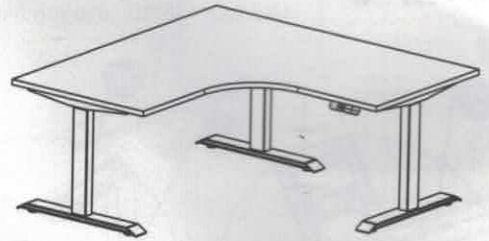

STEP 6

· Connect accessories like controller, hand controller, extension wire, power cord and so on, and fix them with wire clip.

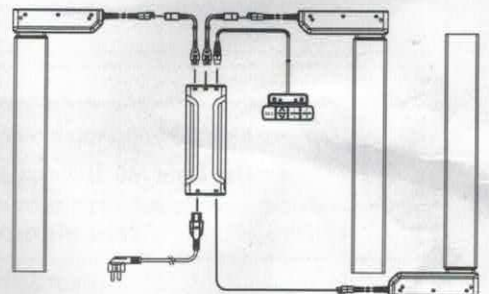
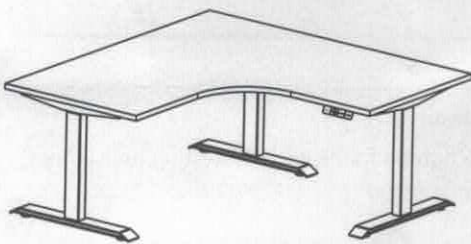

STEP 7

· Use eight M6*10 hexagon flat round head screws in step 3 to fix the wire supporter.
· Use four M6*10 hexagon flat round head screws to fix main frame supporter.

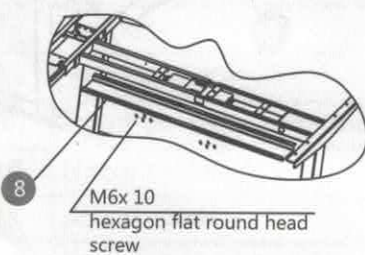

8

M6x 10
hexagon flat round head
screw



9

M6x10 hexagon flat
round head screw

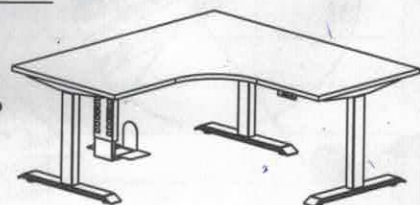

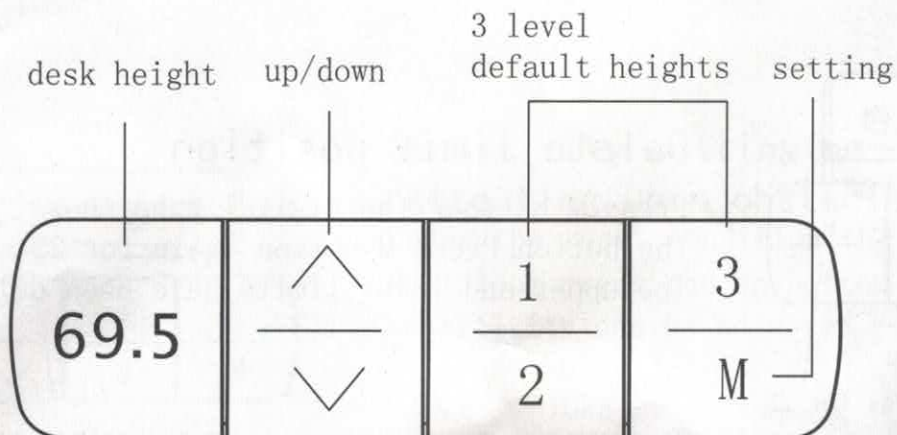

Note Please make sure there is no obstacle during the operation, and there is a gap between desk and wall. And all wires are long enough to allow the up-down of desk.

Advice Please set up as 1 the most comfortable height when you sit down, and set up as 2 the most comfortable height when you stand up. For the other two heights, you can choose whatever you like.

Reset abnormality protection

When there is something wrong with controller reported, the digital tube shows E07-E09. Even if it has access to power after a power cut-off, it will still give an error notice no matter what button you press.

Operation

After pressing for 5s and digital tube shows RST, release the button and press the down button, reset will be activated.

Set up upper limit position

Press M button, the digital tube shows "S-", then release the button. Press the up button, the digital tube will flash once, release the button. Press M button again for 2s, the digital tube shows "999". The upper limit position has been set.

Set up lower limit position

Press M button, the digital tube shows "S-", release the button. Press the down button. The digital tube will flash once. Release the button. Press down M button again for 2s, the digital tube shows "000". The lower limit position has been set.

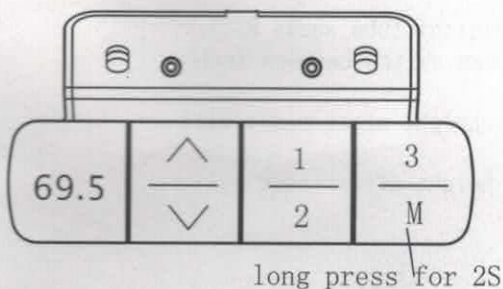
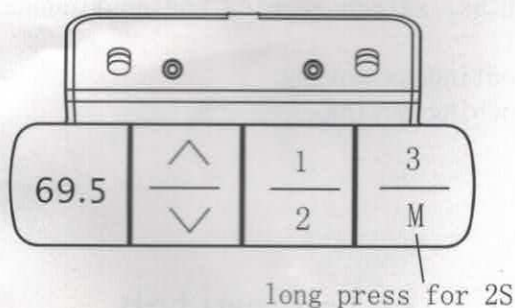
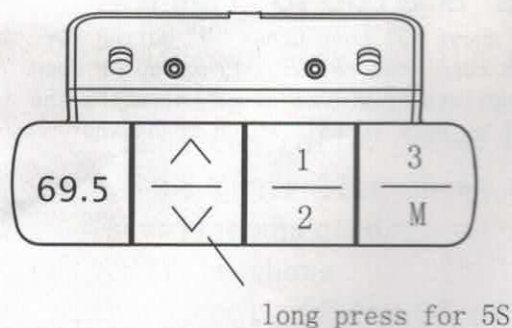

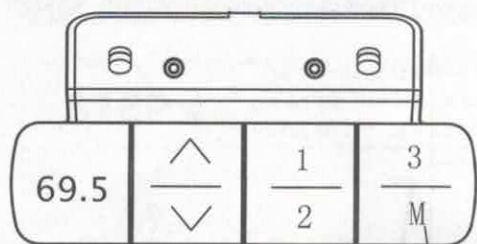

long press for 2S

Delete limit position

Press M button, the digital tube shows "S-", release the button. Press M button again for 2S, it shows "S-". The upper and lower limits have been deleted.

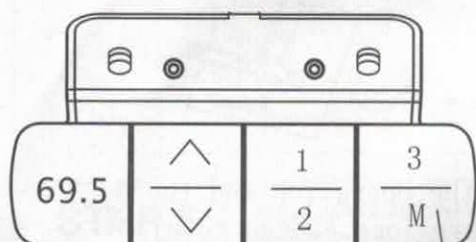

long press for 8S

Lock

Press M button, the digital tube shows "S-", long press M button for 5S, the digital tube shows numbers. Press M button for 3S, it shows LOC. The buttons on the hand controller are locked.

Unlock

Under the LOC condition, long press M button for 8S, it shows numbers. Buttons on hand controller are unlocked.

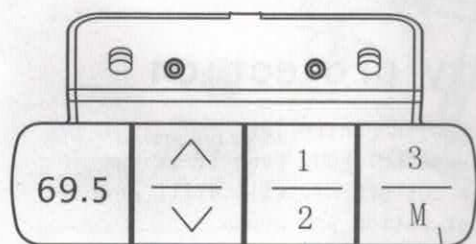

long press for 5S

Revise lowest height

Under the reset condition, it shows RST. Long press "M" button for 5S, it shows the height after reset and twinkles. Press up or down button to adjust to the appropriate height. 5S after releasing the button, the digital tube will go back to RST, which means the amendment is successful.

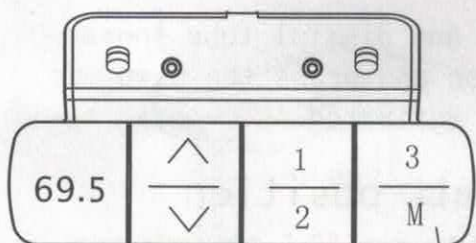

long press for 5S

Switch between memory inching/continuous moving

Under the reset condition (digital tube shows RST) Long press button "1" for 5s, switch inching and continuous moving.

When it shows "10.1", continuous moving.

When it shows "10.2", inching moving.

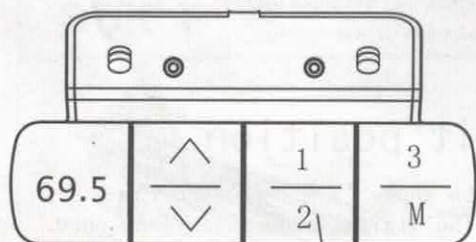

long press for 5S

Centimeter/inch display switch

Under the reset condition (digital tube shows RST), long press "2" for 5s, you can switch between inch display and cm display.

When it shows "10.3", the height after reset will be shown in cm;

When it shows "10.4", the height after reset will be shown in inch.

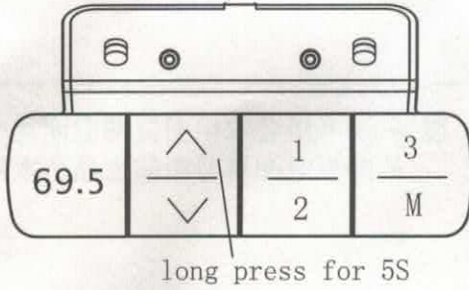

Sensitivity setting on retreating upon obstacle

Under the reset condition (the digital tube shows RST), long press the up button for 5S, the sensitivity can be adjusted.

switch display
 "10.5" --10kg
 "10.6" --15kg
 "10.7" --20kg

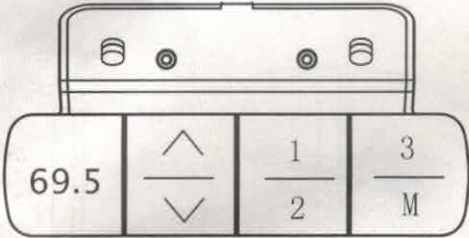

Setting of memory position

Press M button, it shows "S-", select and press one of the memory buttons, current height will be remembered.

Use up/down button to get the desirable height, then repeat the following action.

Normal problems and solutions

1. If your desk has the following issues, please try resetting:
 - Working abnormality
 - Hand controller shows RES (reset)
 - Hand controller shows error (E07, E08), but motor drive wire is well connected.
2. If it shows HOT (hot), please cut off the power and allow it to cool off for 20 minutes.

